



**COMMONWEALTH OF PENNSYLVANIA
DEPARTMENT OF ENVIRONMENTAL PROTECTION
AIR QUALITY PROGRAM**

TITLE V/STATE OPERATING PERMIT

Issue Date: June 22, 2022

Effective Date: July 1, 2022

Expiration Date: June 30, 2027

In accordance with the provisions of the Air Pollution Control Act, the Act of January 8, 1960, P.L. 2119, as amended, and 25 Pa. Code Chapter 127, the Owner, [and Operator if noted] (hereinafter referred to as permittee) identified below is authorized by the Department of Environmental Protection (Department) to operate the air emission source(s) more fully described in this permit. This Facility is subject to all terms and conditions specified in this permit. Nothing in this permit relieves the permittee from its obligations to comply with all applicable Federal, State and Local laws and regulations.

The regulatory or statutory authority for each permit condition is set forth in brackets. All terms and conditions in this permit are federally enforceable applicable requirements unless otherwise designated as "State-Only" or "non-applicable" requirements.

TITLE V Permit No: 36-05142

Federal Tax Id - Plant Code: 20-8940055-1

Owner Information

Name: MARS WRIGLEY US LLC
Mailing Address: 295 S BROWN ST
ELIZABETHTOWN, PA 17022-2127

Plant Information

Plant: MARS WRIGLEY US LLC/ELIZABETHTOWN
Location: 36 Lancaster County 36803 Elizabethtown Borough
SIC Code: 2064 Manufacturing - Candy And Other Confectionery Products

Responsible Official

Name: DAMIEN WEAVER
Title: PLANT DIR
Phone: (717) 367 - 1500 Email:

Permit Contact Person

Name: ANDY KING
Title: HSE SPECIALIST
Phone: (717) 367 - 0955 Email: andy.e.king@effem.com

[Signature] _____
WILLIAMR. WEAVER, SOUTHCENTRAL REGION AIR PROGRAMMANAGER



SECTION A. Table of Contents

Section A. Facility/Source Identification

Table of Contents
Site Inventory List

Section B. General Title V Requirements

- #001 Definitions
- #002 Prohibition of Air Pollution
- #003 Property Rights
- #004 Permit Expiration
- #005 Permit Renewal
- #006 Transfer of Ownership or Operational Control
- #007 Inspection and Entry
- #008 Compliance Requirements
- #009 Need to Halt or Reduce Activity Not a Defense
- #010 Duty to Provide Information
- #011 Reopening and Revising the Title V Permit for Cause
- #012 Reopening a Title V Permit for Cause by EPA
- #013 Operating Permit Application Review by the EPA
- #014 Significant Operating Permit Modifications
- #015 Minor Operating Permit Modifications
- #016 Administrative Operating Permit Amendments
- #017 Severability Clause
- #018 Fee Payment
- #019 Authorization for De Minimis Emission Increases
- #020 Reactivation of Sources
- #021 Circumvention
- #022 Submissions
- #023 Sampling, Testing and Monitoring Procedures
- #024 Compliance Certification
- #025 Recordkeeping Requirements
- #026 Reporting Requirements
- #027 Operational Flexibility
- #028 Risk Management
- #029 Approved Economic Incentives and Emission Trading Programs
- #030 Permit Shield
- #031 Reporting
- #032 Report Format

Section C. Site Level Title V Requirements

- C-I: Restrictions
- C-II: Testing Requirements
- C-III: Monitoring Requirements
- C-IV: Recordkeeping Requirements
- C-V: Reporting Requirements
- C-VI: Work Practice Standards
- C-VII: Additional Requirements
- C-VIII: Compliance Certification
- C-IX: Compliance Schedule

Section D. Source Level Title V Requirements

- D-I: Restrictions
- D-II: Testing Requirements
- D-III: Monitoring Requirements
- D-IV: Recordkeeping Requirements
- D-V: Reporting Requirements



SECTION A. Table of Contents

D-VI: Work Practice Standards
D-VII: Additional Requirements

Note: These same sub-sections are repeated for each source!

Section E. Source Group Restrictions

E-I: Restrictions
E-II: Testing Requirements
E-III: Monitoring Requirements
E-IV: Recordkeeping Requirements
E-V: Reporting Requirements
E-VI: Work Practice Standards
E-VII: Additional Requirements

Section F. Alternative Operating Scenario(s)

F-I: Restrictions
F-II: Testing Requirements
F-III: Monitoring Requirements
F-IV: Recordkeeping Requirements
F-V: Reporting Requirements
F-VI: Work Practice Standards
F-VII: Additional Requirements

Section G. Emission Restriction Summary

Section H. Miscellaneous

**SECTION A. Site Inventory List**

Source ID	Source Name	Capacity/Throughput		Fuel/Material
031	BABCOCK & WILCOX BOILER	91.400	MMBTU/HR	
		650.000	Gal/HR	#2 OIL
		87.900	MCF/HR	NATURAL GAS
032	NEBRASKA BOILER	78.500	MMBTU/HR	
		560.000	Gal/HR	#2 OIL
		75.400	MMCF/HR	NATURAL GAS
103	DIESEL FIRE PUMP			
104	(3) EMERGENCY GENERATORS			
105	Y2K EMERGENCY GENERATOR			
220	DRY MILK PROCESS SYSTEM	2,712.000	Lbs/HR	Dry Milk
230	MILK CRUMB PROCESSING SYSTEM	5,980.000	Lbs/HR	Milk Crumb
240	SUGAR STORAGE AND DISTRIBUTION SYSTEM	3,233.000	Lbs/HR	Sugar
401	JETZONE #1 BEAN CLEANER/SEPARATOR	7,986.000	Lbs/HR	Cocoa Beans
402	JETZONE #1 BEAN ROASTER AND COOLER	7,700.000	Lbs/HR	Cocoa Beans
		7.200	MCF/HR	Natural Gas
403	JETZONE #1 WINNOWING OPERATIONS	4,840.000	Lbs/HR	Cocoa Beans
501	JETZONE #2 COCOA BEAN CLEANING	7,920.000	Lbs/HR	Cocoa Beans
502	JETZONE #2 COCOA BEAN ROASTER & COOLER	7,920.000	Lbs/HR	Cocoa Beans
		1.780	MCF/HR	Natural Gas
503	JETZONE #2 WINNOWER OPERATIONS	7,920.000	Lbs/HR	Cocoa Beans
504	JETZONE #2 PREGRIND OPERATIONS	6,600.000	Lbs/HR	Cocoa Beans
600	BUHLER COCOA BEAN ROASTER	8,000.000	Lbs/HR	COCOA BEANS
601	WINNOWER	7,999.000	Lbs/HR	COCOA BEANS
602	NIB GRINDERS	6,600.000	Lbs/HR	COCOA BEANS
603	BEAN TRANSPORTER	11,020.000	Lbs/HR	COCOA BEANS
604	FINES/SHELL CONVEYING	6,600.000	Lbs/HR	COCOA BEANS
C220A	LACTOSE STORAGE BIN #1 BAGHOUSE (A015)			
C220B	MILK POWDER BIN #2 BAGHOUSE (A049)			
C220C	SUGAR STORAGE BIN #3 BAGHOUSE (A050)			
C220D	MILK ROOM VACUUM SYS BAGHOUSE (A020)			
C230A	MILK CRUMB PULVERIZER BAGHOUSE (A017)			
C230B	MILL SYSTEM "A" BAGHOUSE (A043)			
C230C	MILL SYSTEM "B" BAGHOUSE (A044)			
C230D	MILL SYSTEM "C" BAGHOUSE (A045)			
C230E	MILK CRUMB BIN A (#1) BAGHOUSE (A046)			
C230F	MILK CRUMB BIN B (#2) BAGHOUSE (A047)			
C230G	MILK CRUMB TRANSPORT SYSTEM BAGHOUSE			
C240A	SUGAR STORAGE HOPPER BAGHOUSE			
C240B	SUGAR STORAGE VAC SYS BAGHOUSE (A057)			
C240C	SUGAR STORAGE BIN #1 BAGHOUSE (A060)			
C240D	SUGAR STORAGE BIN #2 BAGHOUSE (A061)			

**SECTION A. Site Inventory List**

Source ID	Source Name	Capacity/Throughput	Fuel/Material
C240E	SUGAR STORAGE BIN #3 BAGHOUSE (A062)		
C240F	SUGAR CONVEYING BAGHOUSE (A063)		
C401	JETZONE #1 BEAN CLEANER BAGHOUSE (A004)		
C402A	JETZONE #1 BEAN ROASTER ZONE #1 CYCLONES		
C402B	JETZONE #1 BEAN ROASTER ZONE #2 CYCLONES		
C402C	JETZONE #1 BEAN COOLER #1 CYCLONE (A001)		
C402D	JETZONE #1 BEAN COOLER #2 CYCLONE (A002)		
C403A	JETZONE #1 BEAN HULLER/WINNOWER #1 BAGHSE (A006)		
C403B	JETZONE #1 BEAN HULLER/WINNOWER #2 BAGHOUSE (A007)		
C501A	JETZONE #2 CENTRAL VAC SYS		
C501B	JETZONE #2 CLEANER/SEPARATOR BAGHOUSE		
C502A	JETZONE #2 ROASTER SCRUBBER ZONE #1 (A101)		
C502B	JETZONE #2 ROASTER SCRUBBER ZONE #2 (A101)		
C502C	JETZONE #2 ROASTER CYCLONE ZONE #1		
C502D	JETZONE #2 ROASTER CYCLONE ZONE #2		
C502E	JETZONE #2 COOLER CYCLONE (A102)		
C503A	JETZONE #2 WINNOWER SYS BAGHOUSE (A104)		
C503B	BEAN SHELL RECEIVER BAGHOUSE (A105)		
C600	ROASTER WET SCRUBBER		
C601	WINNOWER FABRIC FILTER		
C603	BEAN TRANSPORTER FABRIC FILTER		
C604	FINES/SHELL CONVEYING FABRIC FILTER		
FM001	#2 OIL STORAGE TANK		
FM002	NATURAL GAS PIPELINE		
S031	BOILER EXHAUST STACK		
S220A	LACTOSE STORAGE BIN #1 VENT		
S220B	MILK POWDER BIN #2 BAGHOUSE VENT		
S220C	SUGAR BIN #3 BAGHOUSE VENT		
S220D	MILK ROOM VAC SYS BAGHOUSE VENT		
S230A	MILK CRUMB PULVERIZER BAGHOUSE VENT		
S230B	MILL SYSTEM "A" BAGHOUSE VENT		
S230C	MILL SYSTEM "B" BAGHOUSE VENT		
S230D	MILL SYSTEM "C" BAGHOUSE VENT		
S230E	MILK CRUMB BIN #1 BAGHOUSE VENT		
S230F	MILK CRUMB BIN #2 BAGHOUSE VENT		
S230G	MILK CRUMB TRANSPORT BLOWER VENT		
S240A	SUGAR STORAGE HOPPER BAGHOUSE VENT		
S240B	SUGAR STORAGE VAC SYS BAGHOUSE VENT		
S240C	SUGAR STORAGE BIN #1 BAGHOUSE VENT		
S240D	SUGAR STORAGE BIN #2 BAGHOUSE VENT		

**SECTION A. Site Inventory List**

Source ID	Source Name	Capacity/Throughput	Fuel/Material
S240E	SUGAR STORAGE BIN #3 BAGHOUSE VENT		
S240F	SUGAR CONVEYING BAGHOUSE VENT		
S401	JETZONE #1 BEAN CLEANER BAGHOUSE VENT		
S402A	JETZONE #1 ROASTER CYCLONES VENT		
S402B	JETZONE #1 BEAN COOLER #1 CYCLONE VENT		
S402C	JETZONE #1 BEAN COOLER #2 CYCLONE VENT		
S403A	JETZONE #1 BEAN HULR/WINW #1 BAGHOUSE VENT		
S403B	JETZONE #1 BEAN HULR/WINW #2 BAGHOUSE VENT		
S501A	CENTRAL VAC BAGHOUSE VENT		
S501B	JETZONE #2 CLEANER/SEPARATOR BAGHOUSE VENT		
S502A	JETZONE #2 ROASTER ZONE #2 SCRUBBER VENT		
S502B	JETZONE #2 ROASTER ZONE #2 SCRUBBER VENT		
S502C	JETZONE #2 ROASTER ZONE #1 CYCLONE VENT		
S503A	JETZONE #2 WINNOWER BAGHOUSE VENT		
S503B	BEAN SHELL RECEIVER BAGHOUSE VENT		
S600	ROASTER SCRUBBER STACK		
S601	WINNOWER FABRIC FILTER STACK		
S603	BEAN TRANSPORTER COLLECTOR STACK		
S604	FINES/SHELL CONVEYING COLLECTOR STACK		
Z103	SOURCE 103 - FUGITIVE EMISSIONS		
Z104	SOURCE 104 - FUGITIVE EMISSIONS		
Z105	SOURCE 105 - FUGITIVE EMISSIONS		

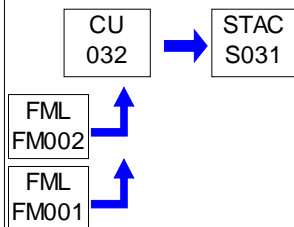
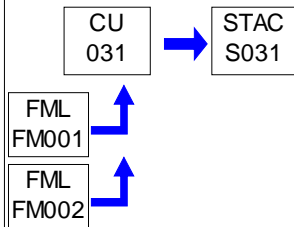
PERMIT MAPS



PERMIT MAPS

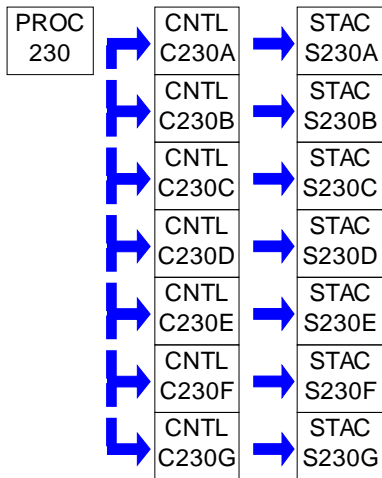
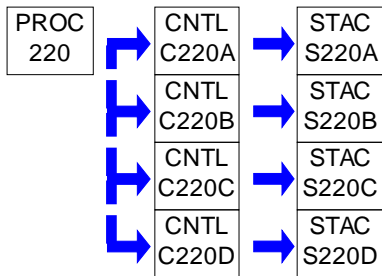
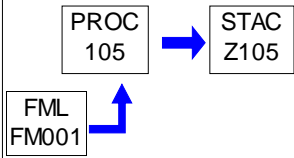
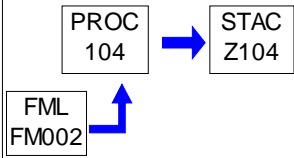
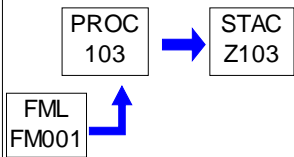



PERMIT MAPS

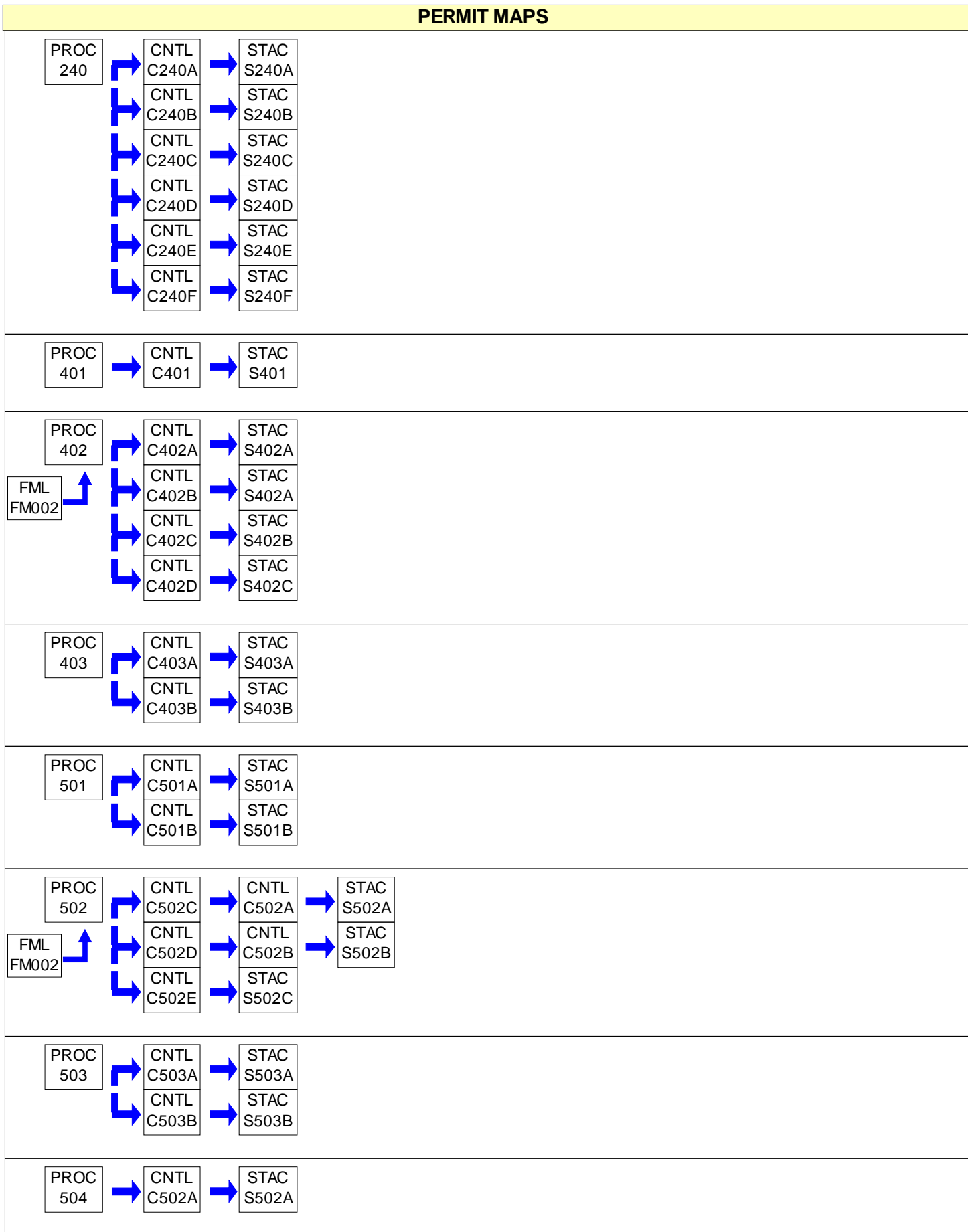



PERMIT MAPS

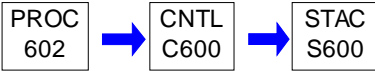
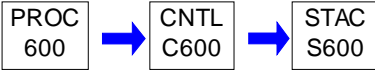

**SECTION B. General Title V Requirements****#001 [25 Pa. Code § 121.1]****Definitions**

Words and terms that are not otherwise defined in this permit shall have the meanings set forth in Section 3 of the Air Pollution Control Act (35 P.S. § 4003) and 25 Pa. Code § 121.1.

#002 [25 Pa. Code § 121.7]**Prohibition of Air Pollution**

No person may permit air pollution as that term is defined in the act.

#003 [25 Pa. Code § 127.512(c)(4)]**Property Rights**

This permit does not convey property rights of any sort, or any exclusive privileges.

#004 [25 Pa. Code § 127.446(a) and (c)]**Permit Expiration**

This operating permit is issued for a fixed term of five (5) years and shall expire on the date specified on Page 1 of this permit. The terms and conditions of the expired permit shall automatically continue pending issuance of a new Title V permit, provided the permittee has submitted a timely and complete application and paid applicable fees required under 25 Pa. Code Chapter 127, Subchapter I and the Department is unable, through no fault of the permittee, to issue or deny a new permit before the expiration of the previous permit. An application is complete if it contains sufficient information to begin processing the application, has the applicable sections completed and has been signed by a responsible official.

#005 [25 Pa. Code §§ 127.412, 127.413, 127.414, 127.446(e), 127.503 & 127.704(b)]**Permit Renewal**

(a) An application for the renewal of the Title V permit shall be submitted to the Department at least six (6) months, and not more than 18 months, before the expiration date of this permit. The renewal application is timely if a complete application is submitted to the Department's Regional Air Manager within the timeframe specified in this permit condition.

(b) The application for permit renewal shall include the current permit number, the appropriate permit renewal fee, a description of any permit revisions and off-permit changes that occurred during the permit term, and any applicable requirements that were promulgated and not incorporated into the permit during the permit term. The fees shall be made payable to "The Commonwealth of Pennsylvania Clean Air Fund" and submitted with the fee form to the respective regional office.

(c) The renewal application shall also include submission of proof that the local municipality and county, in which the facility is located, have been notified in accordance with 25 Pa. Code § 127.413. The application for renewal of the Title V permit shall also include submission of compliance review forms which have been used by the permittee to update information submitted in accordance with either 25 Pa. Code § 127.412(b) or § 127.412(j).

(d) The permittee, upon becoming aware that any relevant facts were omitted or incorrect information was submitted in the permit application, shall promptly submit such supplementary facts or corrected information during the permit renewal process. The permittee shall also promptly provide additional information as necessary to address any requirements that become applicable to the source after the date a complete renewal application was submitted but prior to release of a draft permit.

#006 [25 Pa. Code §§ 127.450(a)(4) & 127.464(a)]**Transfer of Ownership or Operational Control**

(a) In accordance with 25 Pa. Code § 127.450(a)(4), a change in ownership or operational control of the source shall be treated as an administrative amendment if:

- (1) The Department determines that no other change in the permit is necessary;
- (2) A written agreement has been submitted to the Department identifying the specific date of the transfer of permit responsibility, coverage and liability between the current and the new permittee; and,
- (3) A compliance review form has been submitted to the Department and the permit transfer has been approved by

**SECTION B. General Title V Requirements**

the Department.

(b) In accordance with 25 Pa. Code § 127.464(a), this permit may not be transferred to another person except in cases of transfer-of-ownership which are documented and approved to the satisfaction of the Department.

#007 [25 Pa. Code § 127.513, 35 P.S. § 4008 and § 114 of the CAA]**Inspection and Entry**

(a) Upon presentation of credentials and other documents as may be required by law for inspection and entry purposes, the permittee shall allow the Department of Environmental Protection or authorized representatives of the Department to perform the following:

- (1) Enter at reasonable times upon the permittee's premises where a Title V source is located or emissions related activity is conducted, or where records are kept under the conditions of this permit;
- (2) Have access to and copy or remove, at reasonable times, records that are kept under the conditions of this permit;
- (3) Inspect at reasonable times, facilities, equipment including monitoring and air pollution control equipment, practices, or operations regulated or required under this permit;
- (4) Sample or monitor, at reasonable times, substances or parameters, for the purpose of assuring compliance with the permit or applicable requirements as authorized by the Clean Air Act, the Air Pollution Control Act, or the regulations promulgated under the Acts.

(b) Pursuant to 35 P.S. § 4008, no person shall hinder, obstruct, prevent or interfere with the Department or its personnel in the performance of any duty authorized under the Air Pollution Control Act.

(c) Nothing in this permit condition shall limit the ability of the EPA to inspect or enter the premises of the permittee in accordance with Section 114 or other applicable provisions of the Clean Air Act.

#008 [25 Pa. Code §§ 127.25, 127.444, & 127.512(c)(1)]**Compliance Requirements**

(a) The permittee shall comply with the conditions of this permit. Noncompliance with this permit constitutes a violation of the Clean Air Act and the Air Pollution Control Act and is grounds for one (1) or more of the following:

- (1) Enforcement action
- (2) Permit termination, revocation and reissuance or modification
- (3) Denial of a permit renewal application

(b) A person may not cause or permit the operation of a source, which is subject to 25 Pa. Code Article III, unless the source(s) and air cleaning devices identified in the application for the plan approval and operating permit and the plan approval issued to the source are operated and maintained in accordance with specifications in the applications and the conditions in the plan approval and operating permit issued by the Department. A person may not cause or permit the operation of an air contamination source subject to 25 Pa. Code Chapter 127 in a manner inconsistent with good operating practices.

(c) For purposes of Sub-condition (b) of this permit condition, the specifications in applications for plan approvals and operating permits are the physical configurations and engineering design details which the Department determines are essential for the permittee's compliance with the applicable requirements in this Title V permit.

#009 [25 Pa. Code § 127.512(c)(2)]**Need to Halt or Reduce Activity Not a Defense**

It shall not be a defense for a permittee in an enforcement action that it would have been necessary to halt or reduce the permitted activity in order to maintain compliance with the conditions of this permit.

**SECTION B. General Title V Requirements****#010 [25 Pa. Code §§ 127.411(d) & 127.512(c)(5)]****Duty to Provide Information**

(a) The permittee shall furnish to the Department, within a reasonable time, information that the Department may request in writing to determine whether cause exists for modifying, revoking and reissuing, or terminating the permit, or to determine compliance with the permit.

(b) Upon request, the permittee shall also furnish to the Department copies of records that the permittee is required to keep by this permit, or for information claimed to be confidential, the permittee may furnish such records directly to the Administrator of EPA along with a claim of confidentiality.

#011 [25 Pa. Code §§ 127.463, 127.512(c)(3) & 127.542]**Reopening and Revising the Title V Permit for Cause**

(a) This Title V permit may be modified, revoked, reopened and reissued or terminated for cause. The filing of a request by the permittee for a permit modification, revocation and reissuance, or termination, or of a notification of planned changes or anticipated noncompliance does not stay a permit condition.

(b) This permit may be reopened, revised and reissued prior to expiration of the permit under one or more of the following circumstances:

(1) Additional applicable requirements under the Clean Air Act or the Air Pollution Control Act become applicable to a Title V facility with a remaining permit term of three (3) or more years prior to the expiration date of this permit. The Department will revise the permit as expeditiously as practicable but not later than 18 months after promulgation of the applicable standards or regulations. No such revision is required if the effective date of the requirement is later than the expiration date of this permit, unless the original permit or its terms and conditions has been extended.

(2) Additional requirements, including excess emissions requirements, become applicable to an affected source under the acid rain program. Upon approval by the Administrator of EPA, excess emissions offset plans for an affected source shall be incorporated into the permit.

(3) The Department or the EPA determines that this permit contains a material mistake or inaccurate statements were made in establishing the emissions standards or other terms or conditions of this permit.

(4) The Department or the Administrator of EPA determines that the permit must be revised or revoked to assure compliance with the applicable requirements.

(c) Proceedings to revise this permit shall follow the same procedures which apply to initial permit issuance and shall affect only those parts of this permit for which cause to revise exists. The revision shall be made as expeditiously as practicable.

(d) Regardless of whether a revision is made in accordance with (b)(1) above, the permittee shall meet the applicable standards or regulations promulgated under the Clean Air Act within the time frame required by standards or regulations.

#012 [25 Pa. Code § 127.543]**Reopening a Title V Permit for Cause by EPA**

As required by the Clean Air Act and regulations adopted thereunder, this permit may be modified, reopened and reissued, revoked or terminated for cause by EPA in accordance with procedures specified in 25 Pa. Code § 127.543.

#013 [25 Pa. Code § 127.522(a)]**Operating Permit Application Review by the EPA**

The applicant may be required by the Department to provide a copy of the permit application, including the compliance plan, directly to the Administrator of the EPA. Copies of title V permit applications to EPA, pursuant to 25 PA Code §127.522(a), shall be submitted, if required, to the following EPA e-mail box:

R3_Air_Apps_and_Notices@epa.gov

Please place the following in the subject line: TV [permit number], [Facility Name].

**SECTION B. General Title V Requirements****#014 [25 Pa. Code § 127.541]****Significant Operating Permit Modifications**

When permit modifications during the term of this permit do not qualify as minor permit modifications or administrative amendments, the permittee shall submit an application for significant Title V permit modifications in accordance with 25 Pa. Code § 127.541. Notifications to EPA, pursuant to 25 PA Code §127.522(a), if required, shall be submitted, to the following EPA e-mail box:

R3_Air_Apps_and_Notices@epa.gov

Please place the following in the subject line: TV [permit number], [Facility Name].

#015 [25 Pa. Code §§ 121.1 & 127.462]**Minor Operating Permit Modifications**

The permittee may make minor operating permit modifications (as defined in 25 Pa. Code §121.1), on an expedited basis, in accordance with 25 Pa. Code §127.462 (relating to minor operating permit modifications). Notifications to EPA, pursuant to 25 PA Code §127.462(c), if required, shall be submitted, to the following EPA e-mail box:

R3_Air_Apps_and_Notices@epa.gov

Please place the following in the subject line: TV [permit number], [Facility Name].

#016 [25 Pa. Code § 127.450]**Administrative Operating Permit Amendments**

(a) The permittee may request administrative operating permit amendments, as defined in 25 Pa. Code §127.450(a). Copies of request for administrative permit amendment to EPA, pursuant to 25 PA Code §127.450(c)(1), if required, shall be submitted to the following EPA e-mail box:

R3_Air_Apps_and_Notices@epa.gov

Please place the following in the subject line: TV [permit number], [Facility Name].

(b) Upon final action by the Department granting a request for an administrative operating permit amendment covered under §127.450(a)(5), the permit shield provisions in 25 Pa. Code § 127.516 (relating to permit shield) shall apply to administrative permit amendments incorporated in this Title V Permit in accordance with §127.450(c), unless precluded by the Clean Air Act or the regulations thereunder.

#017 [25 Pa. Code § 127.512(b)]**Severability Clause**

The provisions of this permit are severable, and if any provision of this permit is determined by the Environmental Hearing Board or a court of competent jurisdiction, or US EPA to be invalid or unenforceable, such a determination will not affect the remaining provisions of this permit.

#018 [25 Pa. Code §§ 127.704, 127.705 & 127.707]**Fee Payment**

(a) The permittee shall pay fees to the Department in accordance with the applicable fee schedules in 25 Pa. Code Chapter 127, Subchapter I (relating to plan approval and operating permit fees). The applicable fees shall be made payable to "The Commonwealth of Pennsylvania Clean Air Fund" with the permit number clearly indicated and submitted to the respective regional office.

(b) Emission Fees. The permittee shall, on or before September 1st of each year, pay applicable annual Title V emission fees for emissions occurring in the previous calendar year as specified in 25 Pa. Code § 127.705. The permittee is not required to pay an emission fee for emissions of more than 4,000 tons of each regulated pollutant emitted from the facility.

(c) As used in this permit condition, the term "regulated pollutant" is defined as a VOC, each pollutant regulated under Sections 111 and 112 of the Clean Air Act and each pollutant for which a National Ambient Air Quality Standard has been promulgated, except that carbon monoxide is excluded.

**SECTION B. General Title V Requirements**

(d) Late Payment. Late payment of emission fees will subject the permittee to the penalties prescribed in 25 Pa. Code § 127.707 and may result in the suspension or termination of the Title V permit. The permittee shall pay a penalty of fifty percent (50%) of the fee amount, plus interest on the fee amount computed in accordance with 26 U.S.C.A. § 6621(a)(2) from the date the emission fee should have been paid in accordance with the time frame specified in 25 Pa. Code § 127.705(c).

(e) The permittee shall pay an annual operating permit maintenance fee according to the following fee schedule established in 25 Pa. Code § 127.704(d) on or before December 31 of each year for the next calendar year.

- (1) Eight thousand dollars (\$8,000) for calendar years 2021—2025.
- (2) Ten thousand dollars (\$10,000) for calendar years 2026—2030.
- (3) Twelve thousand five hundred dollars (\$12,500) for the calendar years beginning with 2031.

#019 [25 Pa. Code §§ 127.14(b) & 127.449]**Authorization for De Minimis Emission Increases**

(a) This permit authorizes de minimis emission increases from a new or existing source in accordance with 25 Pa. Code §§ 127.14 and 127.449 without the need for a plan approval or prior issuance of a permit modification. The permittee shall provide the Department with seven (7) days prior written notice before commencing any de minimis emissions increase that would result from either: (1) a physical change of minor significance under § 127.14(c)(1); or (2) the construction, installation, modification or reactivation of an air contamination source. The written notice shall:

- (1) Identify and describe the pollutants that will be emitted as a result of the de minimis emissions increase.
- (2) Provide emission rates expressed in tons per year and in terms necessary to establish compliance consistent with any applicable requirement.

The Department may disapprove or condition de minimis emission increases at any time.

(b) Except as provided below in (c) and (d) of this permit condition, the permittee is authorized during the term of this permit to make de minimis emission increases (expressed in tons per year) up to the following amounts without the need for a plan approval or prior issuance of a permit modification:

- (1) Four tons of carbon monoxide from a single source during the term of the permit and 20 tons of carbon monoxide at the facility during the term of the permit.
- (2) One ton of NO_x from a single source during the term of the permit and 5 tons of NO_x at the facility during the term of the permit.
- (3) One and six-tenths tons of the oxides of sulfur from a single source during the term of the permit and 8.0 tons of oxides of sulfur at the facility during the term of the permit.
- (4) Six-tenths of a ton of PM₁₀ from a single source during the term of the permit and 3.0 tons of PM₁₀ at the facility during the term of the permit. This shall include emissions of a pollutant regulated under Section 112 of the Clean Air Act unless precluded by the Clean Air Act or 25 Pa. Code Article III.
- (5) One ton of VOCs from a single source during the term of the permit and 5.0 tons of VOCs at the facility during the term of the permit. This shall include emissions of a pollutant regulated under Section 112 of the Clean Air Act unless precluded by the Clean Air Act or 25 Pa. Code Article III.

(c) In accordance with § 127.14, the permittee may install the following minor sources without the need for a plan approval:

- (1) Air conditioning or ventilation systems not designed to remove pollutants generated or released from other sources.
- (2) Combustion units rated at 2,500,000 or less Btu per hour of heat input.

**SECTION B. General Title V Requirements**

(3) Combustion units with a rated capacity of less than 10,000,000 Btu per hour heat input fueled by natural gas supplied by a public utility, liquefied petroleum gas or by commercial fuel oils which are No. 2 or lighter, viscosity less than or equal to 5.82 c St, and which meet the sulfur content requirements of 25 Pa. Code § 123.22 (relating to combustion units). For purposes of this permit, commercial fuel oil shall be virgin oil which has no reprocessed, recycled or waste material added.

(4) Space heaters which heat by direct heat transfer.

(5) Laboratory equipment used exclusively for chemical or physical analysis.

(6) Other sources and classes of sources determined to be of minor significance by the Department.

(d) This permit does not authorize de minimis emission increases if the emissions increase would cause one or more of the following:

(1) Increase the emissions of a pollutant regulated under Section 112 of the Clean Air Act except as authorized in Subparagraphs (b)(4) and (5) of this permit condition.

(2) Subject the facility to the prevention of significant deterioration requirements in 25 Pa. Code Chapter 127, Subchapter D and/or the new source review requirements in Subchapter E.

(3) Violate any applicable requirement of the Air Pollution Control Act, the Clean Air Act, or the regulations promulgated under either of the acts.

(4) Changes which are modifications under any provision of Title I of the Clean Air Act and emission increases which would exceed the allowable emissions level (expressed as a rate of emissions or in terms of total emissions) under the Title V permit.

(e) Unless precluded by the Clean Air Act or the regulations thereunder, the permit shield described in 25 Pa. Code § 127.516 (relating to permit shield) shall extend to the changes made under 25 Pa. Code § 127.449 (relating to de minimis emission increases).

(f) Emissions authorized under this permit condition shall be included in the monitoring, recordkeeping and reporting requirements of this permit.

(g) Except for de minimis emission increases allowed under this permit, 25 Pa. Code § 127.449, or sources and physical changes meeting the requirements of 25 Pa. Code § 127.14, the permittee is prohibited from making physical changes or engaging in activities that are not specifically authorized under this permit without first applying for a plan approval. In accordance with § 127.14(b), a plan approval is not required for the construction, modification, reactivation, or installation of the sources creating the de minimis emissions increase.

(h) The permittee may not meet de minimis emission threshold levels by offsetting emission increases or decreases at the same source.

#020 [25 Pa. Code §§ 127.11a & 127.215]**Reactivation of Sources**

(a) The permittee may reactivate a source at the facility that has been out of operation or production for at least one year, but less than or equal to five (5) years, if the source is reactivated in accordance with the requirements of 25 Pa. Code §§ 127.11a and 127.215. The reactivated source will not be considered a new source.

(b) A source which has been out of operation or production for more than five (5) years but less than 10 years may be reactivated and will not be considered a new source if the permittee satisfies the conditions specified in 25 Pa. Code § 127.11a(b).

#021 [25 Pa. Code §§ 121.9 & 127.216]**Circumvention**

(a) The owner of this Title V facility, or any other person, may not circumvent the new source review requirements of 25 Pa. Code Chapter 127, Subchapter E by causing or allowing a pattern of ownership or development, including the

**SECTION B. General Title V Requirements**

phasing, staging, delaying or engaging in incremental construction, over a geographic area of a facility which, except for the pattern of ownership or development, would otherwise require a permit or submission of a plan approval application.

(b) No person may permit the use of a device, stack height which exceeds good engineering practice stack height, dispersion technique or other technique which, without resulting in reduction of the total amount of air contaminants emitted, conceals or dilutes an emission of air contaminants which would otherwise be in violation of this permit, the Air Pollution Control Act or the regulations promulgated thereunder, except that with prior approval of the Department, the device or technique may be used for control of malodors.

#022 [25 Pa. Code §§ 127.402(d) & 127.513(1)]**Submissions**

(a) Reports, test data, monitoring data, notifications and requests for renewal of the permit shall be submitted to the:

Regional Air Program Manager
PA Department of Environmental Protection
(At the address given on the permit transmittal letter, or otherwise notified)

(b) Any report or notification for the EPA Administrator or EPA Region III should be addressed to:

Enforcement & Compliance Assurance Division
Air, RCRA and Toxics Branch (3ED21)
Four Penn Center
1600 John F. Kennedy Boulevard
Philadelphia, PA 19103-2852

The Title V compliance certification shall be emailed to EPA at R3_APD_Permits@epa.gov.

(c) An application, form, report or compliance certification submitted pursuant to this permit condition shall contain certification by a responsible official as to truth, accuracy, and completeness as required under 25 Pa. Code § 127.402(d). Unless otherwise required by the Clean Air Act or regulations adopted thereunder, this certification and any other certification required pursuant to this permit shall state that, based on information and belief formed after reasonable inquiry, the statements and information in the document are true, accurate and complete.

#023 [25 Pa. Code §§ 127.441(c) & 127.463(e); Chapter 139; & 114(a)(3), 504(b) of the CAA]**Sampling, Testing and Monitoring Procedures**

(a) The permittee shall perform the emissions monitoring and analysis procedures or test methods for applicable requirements of this Title V permit. In addition to the sampling, testing and monitoring procedures specified in this permit, the Permittee shall comply with any additional applicable requirements promulgated under the Clean Air Act after permit issuance regardless of whether the permit is revised.

(b) The sampling, testing and monitoring required under the applicable requirements of this permit, shall be conducted in accordance with the requirements of 25 Pa. Code Chapter 139 unless alternative methodology is required by the Clean Air Act (including §§ 114(a)(3) and 504(b)) and regulations adopted thereunder.

#024 [25 Pa. Code § 127.513]**Compliance Certification**

(a) One year after the date of issuance of the Title V permit, and each year thereafter, unless specified elsewhere in the permit, the permittee shall submit to the Department and EPA Region III a certificate of compliance with the terms and conditions in this permit, for the previous year, including the emission limitations, standards or work practices. This certification shall include:

- (1) The identification of each term or condition of the permit that is the basis of the certification.
- (2) The compliance status.
- (3) The methods used for determining the compliance status of the source, currently and over the reporting period.
- (4) Whether compliance was continuous or intermittent.

(b) The compliance certification shall be postmarked or hand-delivered no later than thirty days after each anniversary of

**SECTION B. General Title V Requirements**

the date of issuance of this Title V Operating Permit, or on the submittal date specified elsewhere in the permit, to the Department in accordance with the submission requirements specified in Section B, Condition #022 of this permit. The Title V compliance certification shall be emailed to EPA at R3_APD_Permits@epa.gov.

#025 [25 Pa. Code §§ 127.511 & Chapter 135]**Recordkeeping Requirements**

(a) The permittee shall maintain and make available, upon request by the Department, records of required monitoring information that include the following:

- (1) The date, place (as defined in the permit) and time of sampling or measurements.
- (2) The dates the analyses were performed.
- (3) The company or entity that performed the analyses.
- (4) The analytical techniques or methods used.
- (5) The results of the analyses.
- (6) The operating conditions as existing at the time of sampling or measurement.

(b) The permittee shall retain records of the required monitoring data and supporting information for at least five (5) years from the date of the monitoring sample, measurement, report or application. Supporting information includes the calibration data and maintenance records and original strip-chart recordings for continuous monitoring instrumentation, and copies of reports required by the permit.

(c) The permittee shall maintain and make available to the Department upon request, records including computerized records that may be necessary to comply with the reporting, recordkeeping and emission statement requirements in 25 Pa. Code Chapter 135 (relating to reporting of sources). In accordance with 25 Pa. Code Chapter 135, § 135.5, such records may include records of production, fuel usage, maintenance of production or pollution control equipment or other information determined by the Department to be necessary for identification and quantification of potential and actual air contaminant emissions. If direct recordkeeping is not possible or practical, sufficient records shall be kept to provide the needed information by indirect means.

#026 [25 Pa. Code §§ 127.411(d), 127.442, 127.463(e) & 127.511(c)]**Reporting Requirements**

(a) The permittee shall comply with the reporting requirements for the applicable requirements specified in this Title V permit. In addition to the reporting requirements specified herein, the permittee shall comply with any additional applicable reporting requirements promulgated under the Clean Air Act after permit issuance regardless of whether the permit is revised.

(b) Pursuant to 25 Pa. Code § 127.511(c), the permittee shall submit reports of required monitoring at least every six (6) months unless otherwise specified in this permit. Instances of deviations (as defined in 25 Pa. Code § 121.1) from permit requirements shall be clearly identified in the reports. The reporting of deviations shall include the probable cause of the deviations and corrective actions or preventative measures taken, except that sources with continuous emission monitoring systems shall report according to the protocol established and approved by the Department for the source. The required reports shall be certified by a responsible official.

(c) Every report submitted to the Department under this permit condition shall comply with the submission procedures specified in Section B, Condition #022(c) of this permit.

(d) Any records, reports or information obtained by the Department or referred to in a public hearing shall be made available to the public by the Department except for such records, reports or information for which the permittee has shown cause that the documents should be considered confidential and protected from disclosure to the public under Section 4013.2 of the Air Pollution Control Act and consistent with Sections 112(d) and 114(c) of the Clean Air Act and 25 Pa. Code § 127.411(d). The permittee may not request a claim of confidentiality for any emissions data generated for the Title V facility.

**SECTION B. General Title V Requirements****#027 [25 Pa. Code § 127.3]****Operational Flexibility**

The permittee is authorized to make changes within the Title V facility in accordance with the following provisions in 25 Pa. Code Chapter 127 which implement the operational flexibility requirements of Section 502(b)(10) of the Clean Air Act and Section 6.1(i) of the Air Pollution Control Act:

- (1) Section 127.14 (relating to exemptions)
- (2) Section 127.447 (relating to alternative operating scenarios)
- (3) Section 127.448 (relating to emissions trading at facilities with federally enforceable emissions caps)
- (4) Section 127.449 (relating to de minimis emission increases)
- (5) Section 127.450 (relating to administrative operating permit amendments)
- (6) Section 127.462 (relating to minor operating permit amendments)
- (7) Subchapter H (relating to general plan approvals and operating permits)

#028 [25 Pa. Code §§ 127.441(d), 127.512(i) and 40 CFR Part 68]**Risk Management**

(a) If required by Section 112(r) of the Clean Air Act, the permittee shall develop and implement an accidental release program consistent with requirements of the Clean Air Act, 40 CFR Part 68 (relating to chemical accident prevention provisions) and the Federal Chemical Safety Information, Site Security and Fuels Regulatory Relief Act (P.L. 106-40).

(b) The permittee shall prepare and implement a Risk Management Plan (RMP) which meets the requirements of Section 112(r) of the Clean Air Act, 40 CFR Part 68 and the Federal Chemical Safety Information, Site Security and Fuels Regulatory Relief Act when a regulated substance listed in 40 CFR § 68.130 is present in a process in more than the listed threshold quantity at the Title V facility. The permittee shall submit the RMP to the federal Environmental Protection Agency according to the following schedule and requirements:

- (1) The permittee shall submit the first RMP to a central point specified by EPA no later than the latest of the following:
 - (i) Three years after the date on which a regulated substance is first listed under § 68.130; or,
 - (ii) The date on which a regulated substance is first present above a threshold quantity in a process.

(2) The permittee shall submit any additional relevant information requested by the Department or EPA concerning the RMP and shall make subsequent submissions of RMPs in accordance with 40 CFR § 68.190.

(3) The permittee shall certify that the RMP is accurate and complete in accordance with the requirements of 40 CFR Part 68, including a checklist addressing the required elements of a complete RMP.

(c) As used in this permit condition, the term "process" shall be as defined in 40 CFR § 68.3. The term "process" means any activity involving a regulated substance including any use, storage, manufacturing, handling, or on-site movement of such substances or any combination of these activities. For purposes of this definition, any group of vessels that are interconnected, or separate vessels that are located such that a regulated substance could be involved in a potential release, shall be considered a single process.

(d) If the Title V facility is subject to 40 CFR Part 68, as part of the certification required under this permit, the permittee shall:

- (1) Submit a compliance schedule for satisfying the requirements of 40 CFR Part 68 by the date specified in 40 CFR § 68.10(a); or,
- (2) Certify that the Title V facility is in compliance with all requirements of 40 CFR Part 68 including the registration and submission of the RMP.

**SECTION B. General Title V Requirements**

(e) If the Title V facility is subject to 40 CFR Part 68, the permittee shall maintain records supporting the implementation of an accidental release program for five (5) years in accordance with 40 CFR § 68.200.

(f) When the Title V facility is subject to the accidental release program requirements of Section 112(r) of the Clean Air Act and 40 CFR Part 68, appropriate enforcement action will be taken by the Department if:

(1) The permittee fails to register and submit the RMP or a revised plan pursuant to 40 CFR Part 68.

(2) The permittee fails to submit a compliance schedule or include a statement in the compliance certification required under Section B, Condition #026 of this permit that the Title V facility is in compliance with the requirements of Section 112(r) of the Clean Air Act, 40 CFR Part 68, and 25 Pa. Code § 127.512(i).

#029 [25 Pa. Code § 127.512(e)]**Approved Economic Incentives and Emission Trading Programs**

No permit revision shall be required under approved economic incentives, marketable permits, emissions trading and other similar programs or processes for changes that are provided for in this Title V permit.

#030 [25 Pa. Code §§ 127.516, 127.450(d), 127.449(f) & 127.462(g)]**Permit Shield**

(a) The permittee's compliance with the conditions of this permit shall be deemed in compliance with applicable requirements (as defined in 25 Pa. Code § 121.1) as of the date of permit issuance if either of the following applies:

(1) The applicable requirements are included and are specifically identified in this permit.

(2) The Department specifically identifies in the permit other requirements that are not applicable to the permitted facility or source.

(b) Nothing in 25 Pa. Code § 127.516 or the Title V permit shall alter or affect the following:

(1) The provisions of Section 303 of the Clean Air Act, including the authority of the Administrator of the EPA provided thereunder.

(2) The liability of the permittee for a violation of an applicable requirement prior to the time of permit issuance.

(3) The applicable requirements of the acid rain program, consistent with Section 408(a) of the Clean Air Act.

(4) The ability of the EPA to obtain information from the permittee under Section 114 of the Clean Air Act.

(c) Unless precluded by the Clean Air Act or regulations thereunder, final action by the Department incorporating a significant permit modification in this Title V Permit shall be covered by the permit shield at the time that the permit containing the significant modification is issued.

#031 [25 Pa. Code §135.3]**Reporting**

(a) The permittee shall submit by March 1 of each year an annual emissions report for the preceding calendar year. The report shall include information for all active previously reported sources, new sources which were first operated during the preceding calendar year, and sources modified during the same period which were not previously reported. All air emissions from the facility should be estimated and reported.

(b) A source owner or operator may request an extension of time from the Department for the filing of an annual emissions report, and the Department may grant the extension for reasonable cause.

#032 [25 Pa. Code §135.4]**Report Format**

Emissions reports shall contain sufficient information to enable the Department to complete its emission inventory. Emissions reports shall be made by the source owner or operator in a format specified by the Department.

**SECTION C. Site Level Requirements****I. RESTRICTIONS.****Emission Restriction(s).****# 001 [25 Pa. Code §123.1]****Prohibition of certain fugitive emissions**

No person shall permit the emission into the outdoor atmosphere of any fugitive air contaminant from a source other than the following:

- (1) Construction or demolition of buildings or structures.
- (2) Grading, paving and maintenance of roads and streets.
- (3) Use of roads and streets. Emissions from material in or on trucks, railroad cars and other vehicular equipment are not considered as emissions from use of roads and streets.
- (4) Clearing of land.
- (5) Stockpiling of materials.
- (6) Open burning operations.
- (7) Sources and classes of sources other than those identified above for which the operator has obtained a determination from the Department, in accordance with 25 Pa Code 123.1(b), that emissions from the source, after appropriate control, meet the following requirements:
 - (a) the emissions are of minor significance with respect to causing air pollution; and
 - (b) the emissions are not preventing or interfering with the attainment or maintenance of any ambient air quality standard.

002 [25 Pa. Code §123.2]**Fugitive particulate matter**

No person shall permit fugitive particulate matter to be emitted into the outdoor atmosphere from a source specified in Section C, Condition #001 (relating to prohibition of certain fugitive emissions) if such emissions are visible at the point the emissions pass outside the person's property.

003 [25 Pa. Code §123.31]**Limitations**

No person shall permit the emission into the outdoor atmosphere of any malodorous air contaminants from any source in such a manner that the malodors are detectable outside the property of the person on whose land the source is being operated.

004 [25 Pa. Code §123.41]**Limitations**

The permittee shall not permit the emission into the outdoor atmosphere of visible air contaminants in such a manner that the opacity of the emission is either of the following:

- (1) Equal to or greater than 20% for a period or periods aggregating more than three minutes in any 1 hour.
- (2) Equal to or greater than 60% at any time.

005 [25 Pa. Code §127.441]**Operating permit terms and conditions.**

The facility shall limit NOx emissions to less than 100 tpy based on a 12-month consecutive period.

006 [25 Pa. Code §129.14]**Open burning operations**

(a) No person may permit the open burning of material in a manner that:

- (1) The emissions are visible, at any time, at the point such emissions pass outside the property of the person on whose

**SECTION C. Site Level Requirements**

land the open burning is being conducted.

(2) Malodorous air contaminants from the open burning are detectable outside the property of the person on whose land the open burning is being conducted.

(3) The emissions interfere with the reasonable enjoyment of life or property.

(4) The emissions cause damage to vegetation or property.

(5) The emissions are or may be deleterious to human or animal health.

(b) Exceptions: The requirements of subsection (a) do not apply where the open burning operations result from:

(1) A fire set to prevent or abate a fire hazard, when approved by the Department and set by or under the supervision of a public officer.

(2) A fire set for the purpose of instructing personnel in fire fighting, when approved by the Department.

(3) A fire set for the prevention and control of disease or pests, when approved by the Department.

(4) A fire set in conjunction with the production of agricultural commodities in their unmanufactured state on the premises of the farm operation.

(5) A fire set solely for recreational or ceremonial purposes.

(6) A fire set solely for cooking food.

This permit condition does not constitute authorization to burn solid waste in violation of Section 610(3) of the Solid Waste Management Act (SWMA), contained in 35 P.S. Section 6018.610(3), or any other provision of the SWMA.

II. TESTING REQUIREMENTS.**# 007 [25 Pa. Code §127.441]****Operating permit terms and conditions.**

The Department reserves the right to require exhaust stack testing of the sources referenced in this permit as necessary during the permit term to verify emissions for purposes including, emission fees, malfunctions or permit condition violations.

008 [25 Pa. Code §139.1]**Sampling facilities.**

Upon the request of the Department, the permittee shall provide adequate sampling ports, safe sampling platforms and adequate utilities for the performance by the Department of tests on such source. The Department will set forth, in the request, the time period in which the facilities shall be provided as well as the specifications for such facilities.

009 [25 Pa. Code §139.11]**General requirements.**

The following are applicable to source tests for determining emissions from stationary sources:

(1) Performance tests shall be conducted while the source is operating at maximum routine operating conditions or under such other conditions, within the capacity of the equipment, as may be requested by the Department.

(2) The Department will consider for approval where sufficient information is provided to verify the source conditions existing at the time of the test and where adequate data is available to show the manner in which the test was conducted. Information submitted to the Department shall include, as a minimum all of the following:

(i) A thorough source description, including a description of any air cleaning devices and the flue.

**SECTION C. Site Level Requirements**

- (ii) Process conditions, for example, the charging rate of raw material or rate of production of final product, boiler pressure, oven temperature, and other conditions which may affect emissions from the process.
- (iii) The location of the sampling ports.
- (iv) Effluent characteristics, including velocity, temperature, moisture content, gas density (percentage CO, CO₂, O₂ and N₂), static and barometric pressures.
- (v) Sample collection techniques employed, including procedures used, equipment descriptions and data to verify that isokinetic sampling for particulate matter collection occurred and that acceptable test conditions were met.
- (vi) Laboratory procedures and results.
- (vii) Calculated results.

III. MONITORING REQUIREMENTS.**# 010 [25 Pa. Code §123.43]****Measuring techniques**

Visible emissions may be measured using either of the following:

- 1) A device approved by the Department and maintained to provide accurate opacity measurements.
- 2) Observers, trained and certified, to measure plume opacity with the naked eye or with the aid of devices approved by the Department.

011 [25 Pa. Code §127.441]**Operating permit terms and conditions.**

The permittee shall conduct a weekly inspection around the plant periphery during daylight hours when the plant is in production to detect visible emissions, fugitive emissions leaving the premises and malodorous air emissions as follows:

- (a) Visible emissions in excess of the limits stated in Section C, Condition #004. Visible emissions may be measured according to the methods specified in Section C, Condition #010, or as an alternative, plant personnel who observe visible emissions may report the incidence of visible emissions to the Department within two hours of each incident and make arrangements for a certified observer to verify the visible emissions.
- (b) The presence of fugitive emissions beyond the plant boundaries as stated in Section C, Condition #002.
- (c) The presence of malodorous air emissions beyond the plant boundaries as stated in Section C, Condition #003.

IV. RECORDKEEPING REQUIREMENTS.**# 012 [25 Pa. Code §127.441]****Operating permit terms and conditions.**

The permittee shall maintain a logbook or make use of a data logging system of all the weekly inspections as described in Section C, Condition #011, for recording instances of visible emissions, fugitive emissions and malodorous air emissions. The records shall include, at a minimum, the following information:

- (1) The name of the company representative monitoring each instances.
- (2) A description of the emissions and/or malodors observed, and actions taken to mitigate them.
- (3) The date and time of each observation.
- (4) The wind direction during each observation.

Note: a log or data entry for each of the above periphery inspections is required whether or not the presence of visible, fugitive, or odorous emissions were detected.

**SECTION C. Site Level Requirements****# 013 [25 Pa. Code §127.441]****Operating permit terms and conditions.**

All records required by this operating permit and subsequent issuances shall be maintained for the most recent five-year period and made available to Department representatives upon request.

014 [25 Pa. Code §127.441]**Operating permit terms and conditions.**

The permittee shall maintain detailed records of all scheduled and unscheduled maintenance performed on the air emissions control systems for the most recent five-year period.

015 [25 Pa. Code §127.441]**Operating permit terms and conditions.**

The permittee shall calculate monthly emissions for each calendar month and total facility emissions for each consecutive 12-month period for the following pollutants:

- a. NOx
- b. SO₂
- c. CO
- d. PM/PM₁₀
- e. VOC
- f. individual Hazardous Air Pollutants (HAP)
- g. combined Hazardous Air Pollutants (HAPs)

016 [25 Pa. Code §135.5]**Recordkeeping**

Source owners or operators shall maintain and make available upon request by the Department records including computerized records that may be necessary to comply with 25 PA Code 135.3 and 135.21 (relating to reporting; and emission statements). These may include records of production, fuel usage, maintenance of production or pollution control equipment or other information determined by the Department to be necessary for identification and quantification of potential and actual air contaminant emissions. If direct recordkeeping is not possible or practical, sufficient records shall be kept to provide the needed information by indirect means.

V. REPORTING REQUIREMENTS.**# 017 [25 Pa. Code §127.442]****Reporting requirements.**

(a) The permittee shall report malfunctions which occur at the facility to the Department. As defined in 40 CFR Section 60.2 and incorporated by reference in 25 Pa. Code Chapter 122, a malfunction is any sudden, infrequent and not reasonably preventable failure of air pollution control equipment, process equipment, or a process to operate in a normal or usual manner. Failures that are caused in part by poor maintenance or careless operation are not malfunctions. Malfunctions shall be reported as follows:

(1) Any malfunction which poses an imminent danger to the public health, safety, welfare and environment, shall be immediately reported to the Department by telephone. The telephone report of such malfunctions shall occur no later than two (2) hours after the permittee is aware of the malfunction. The permittee shall submit a written report of instances of such malfunctions to the Department within three (3) days of the telephone report.

(2) Unless otherwise required by this permit, any other malfunction that is not subject to the reporting requirements of paragraph (1) above, shall be reported to the Department, in writing, within five (5) days of discovery of the malfunction.

(b) Unless otherwise approved by DEP, all malfunctions shall be reported to wborst@pa.gov.

(c) Telephone reports can be made to the Reading District Office at 610-916-0100 during normal business hours, or to the Department's Emergency Hotline at any time. The Emergency Hotline phone number is changed/updated periodically. The current Emergency Hotline phone number can be found at:

<https://www.dep.pa.gov/About/Regional/SouthcentralRegion/Pages/default.aspx>. The permittee shall submit a written report

**SECTION C. Site Level Requirements**

of instances of such malfunctions to the Department within three (3) days of the telephone report.

018 [25 Pa. Code §135.4]**Report format**

All source reports shall contain sufficient information to enable the Department to complete its emission inventory. Source reports shall be made by the source owner or operator in a format specified by the Department.

VI. WORK PRACTICE REQUIREMENTS.**# 019 [25 Pa. Code §123.1]****Prohibition of certain fugitive emissions**

The permittee shall take all reasonable actions to prevent particulate matter from the sources identified in Section C, Condition #001 (1) through (6) from becoming airborne. These actions shall include, but are not limited to the following:

- (1) Use, where possible, of water or chemicals for control of dust in the demolition of buildings or structures, construction operations, the grading of roads or the clearing of land.
- (2) Application of asphalt, oil, water or suitable chemicals on dirt roads, material stockpiles and other surfaces which create airborne dusts.
- (3) Paving and maintenance of roadways.
- (4) Prompt removal of earth or other material from paved streets onto which earth or other material has been transported by trucking or earth moving equipment, erosion by water or other means.

VII. ADDITIONAL REQUIREMENTS.**# 020 [25 Pa. Code §127.207]****ERC generation and creation.**

1) The Creditable Emission Decreases or ERCs that are approved for the shutdown of the Cocoa Bean Micronizer and the Cocoa Bean Roasting System (Sources 301 & 303) at Mars Wrigley Confectionery, LLC located at 295 Brown Street, Elizabethtown Borough, Lancaster County are 19.13 tpy of VOCs and 0.428 tpy of NOx. In accordance with 25 Pa Code Section 127.206(f), the generated ERCs for the shutdown of the Cocoa Bean Roasting System and Micronizer will expire as offsets on August 12, 2027.

2) These ERCs may be used after the approved entry of the ERCs by the Department in the Pennsylvania ERC Registry.

3) Pursuant to 25 Pa. Code Section 127.207(7), if the source(s) addressed in this ERC approval has not been dismantled or removed, the owner or operator shall on an annual basis certify in writing to the Department the continuance of the shutdown.

4) The permittee and any subsequent user of this ERC approval shall comply with the requirements of 25 Pa. Code Sections 127.206 – 127.209.

021 [25 Pa. Code §127.441]**Operating permit terms and conditions.**

Operation of any air emissions source is contingent upon proper operation of its associated emissions control system, unless otherwise approved by the Department.

022 [25 Pa. Code §127.441]**Operating permit terms and conditions.**

The permittee shall operate and maintain all sources and any air cleaning devices identified in this operating permit in accordance with the manufacturer's recommendations/specifications, as well as in a manner consistent with good operating practices.

**SECTION C. Site Level Requirements****# 023 [25 Pa. Code §127.441]****Operating permit terms and conditions.**

(a) This Title V Operating Permit incorporates by reference all of the provisions of Plan Approvals 36-05142C and 36-05142D. Based on this incorporation, any violation of the plan approval would also be deemed a violation of this Title V Operating Permit.

(b) This incorporation of Plan Approvals 36-05142C and 36-05142D into this Title V Operating Permit shall not be construed to require the permittee to implement the projects that are the subject of the plan approval, unless an enforcement action, regulation or statute independently requires otherwise.

(c) This Title V permit shall not be construed to provide any independent, ongoing authority for the construction or operation of the projects that are the subjects of Plan Approvals 36-05142C and 36-05142D unless and until the permittee applies for, and is granted, future administrative amendment(s) to this Title V permit for the projects. Application for an administrative amendment would occur after the plan approval equipment has been determined by DEP to have completed its temporary operation phase under the authority of the plan approval.

024 [25 Pa. Code §127.444]**Compliance requirements.**

In accordance with the requirement for the submittal of an annual compliance certification as listed below in Section C, VIII, "Compliance Certification", the permittee shall submit an electronic copy to EPA Region 3 at: R3_APD_Permits@epa.gov.

VIII. COMPLIANCE CERTIFICATION.

The permittee shall submit within thirty days of 01/01/2023 a certificate of compliance with all permit terms and conditions set forth in this Title V permit as required under condition #026 of section B of this permit, and annually thereafter.

IX. COMPLIANCE SCHEDULE.

No compliance milestones exist.

***** Permit Shield In Effect *****

**SECTION D. Source Level Requirements**

Source ID: 031

Source Name: BABCOCK & WILCOX BOILER

Source Capacity/Throughput: 91.400 MMBTU/HR
 650.000 Gal/HR #2 OIL
 87.900 MCF/HR NATURAL GAS

Conditions for this source occur in the following groups: GROUP 001A
 GROUP 003
 GROUP 004

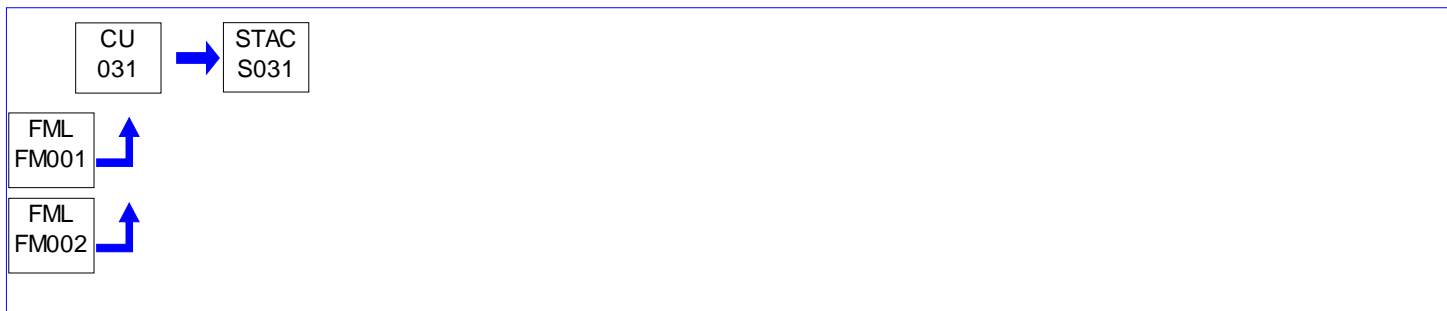
**I. RESTRICTIONS.**

No additional requirements exist except as provided in other sections of this permit including Section B (Title V General Requirements) and/or Section E (Source Group Restrictions).

II. TESTING REQUIREMENTS.

No additional testing requirements exist except as provided in other sections of this permit including Section B (Title V General Requirements) and/or Section E (Source Group Restrictions).

III. MONITORING REQUIREMENTS.

No additional monitoring requirements exist except as provided in other sections of this permit including Section B (Title V General Requirements) and/or Section E (Source Group Restrictions).

IV. RECORDKEEPING REQUIREMENTS.

No additional record keeping requirements exist except as provided in other sections of this permit including Section B (Title V General Requirements) and/or Section E (Source Group Restrictions).

V. REPORTING REQUIREMENTS.

No additional reporting requirements exist except as provided in other sections of this permit including Section B (Title V General Requirements) and/or Section E (Source Group Restrictions).

VI. WORK PRACTICE REQUIREMENTS.

No additional work practice requirements exist except as provided in other sections of this permit including Section B (Title V General Requirements) and/or Section E (Source Group Restrictions).

VII. ADDITIONAL REQUIREMENTS.

No additional requirements exist except as provided in other sections of this permit including Section B (Title V General Requirements) and/or Section E (Source Group Restrictions).



SECTION D. Source Level Requirements

***** Permit Shield in Effect. *****

**SECTION D. Source Level Requirements**

Source ID: 032

Source Name: NEBRASKA BOILER

Source Capacity/Throughput:	78.500	MMBTU/HR	
	560.000	Gal/HR	#2 OIL
	75.400	MMCF/HR	NATURAL GAS

Conditions for this source occur in the following groups: GROUP 001A
 GROUP 003
 GROUP 004
 GROUP 006

**I. RESTRICTIONS.**

No additional requirements exist except as provided in other sections of this permit including Section B (Title V General Requirements) and/or Section E (Source Group Restrictions).

II. TESTING REQUIREMENTS.

No additional testing requirements exist except as provided in other sections of this permit including Section B (Title V General Requirements) and/or Section E (Source Group Restrictions).

III. MONITORING REQUIREMENTS.

No additional monitoring requirements exist except as provided in other sections of this permit including Section B (Title V General Requirements) and/or Section E (Source Group Restrictions).

IV. RECORDKEEPING REQUIREMENTS.

No additional record keeping requirements exist except as provided in other sections of this permit including Section B (Title V General Requirements) and/or Section E (Source Group Restrictions).

V. REPORTING REQUIREMENTS.

No additional reporting requirements exist except as provided in other sections of this permit including Section B (Title V General Requirements) and/or Section E (Source Group Restrictions).

VI. WORK PRACTICE REQUIREMENTS.

No additional work practice requirements exist except as provided in other sections of this permit including Section B (Title V General Requirements) and/or Section E (Source Group Restrictions).

VII. ADDITIONAL REQUIREMENTS.

No additional requirements exist except as provided in other sections of this permit including Section B (Title V General Requirements) and/or Section E (Source Group Restrictions).



SECTION D. Source Level Requirements

***** Permit Shield in Effect. *****

**SECTION D. Source Level Requirements**

Source ID: 103

Source Name: DIESEL FIRE PUMP

Source Capacity/Throughput:

Conditions for this source occur in the following groups: GROUP 005

**I. RESTRICTIONS.****Emission Restriction(s).****# 001 [25 Pa. Code §123.21]****General**

No person may permit the emission into the outdoor atmosphere of sulfur oxides from a source in a manner that the concentration of the sulfur oxides, expressed as SO₂, in the effluent gas exceeds 500 parts per million, by volume, dry basis.

002 [25 Pa. Code §127.441]**Operating permit terms and conditions.**

(a) Operation of the emergency fire water pump will be limited to 168 hours per year with maximum NO_x emissions of 0.54 tpy, based on any consecutive 12-month rolling period.

(b) The permittee shall operate, maintain, and monitor a fuel usage meter on the above pump to measure and record the amount of fuel used on a monthly basis.

(c) The No. 2 fuel oil used in the above generator shall not exceed 0.5% sulfur by weight.

II. TESTING REQUIREMENTS.

No additional testing requirements exist except as provided in other sections of this permit including Section B (Title V General Requirements) and/or Section E (Source Group Restrictions).

III. MONITORING REQUIREMENTS.**# 003 [25 Pa. Code §127.441]****Operating permit terms and conditions.**

The permittee shall operate, maintain, and monitor the hour-run-meter on the emergency fire pump to record the operating time. Records shall be maintained on a monthly basis.

IV. RECORDKEEPING REQUIREMENTS.

No additional record keeping requirements exist except as provided in other sections of this permit including Section B (Title V General Requirements) and/or Section E (Source Group Restrictions).

V. REPORTING REQUIREMENTS.

No additional reporting requirements exist except as provided in other sections of this permit including Section B (Title V General Requirements) and/or Section E (Source Group Restrictions).



SECTION D. Source Level Requirements

VI. WORK PRACTICE REQUIREMENTS.

No additional work practice requirements exist except as provided in other sections of this permit including Section B (Title V General Requirements) and/or Section E (Source Group Restrictions).

VII. ADDITIONAL REQUIREMENTS.

No additional requirements exist except as provided in other sections of this permit including Section B (Title V General Requirements) and/or Section E (Source Group Restrictions).

***** Permit Shield in Effect. *****

**SECTION D. Source Level Requirements**

Source ID: 104

Source Name: (3) EMERGENCY GENERATORS

Source Capacity/Throughput:

Conditions for this source occur in the following groups: GROUP 005

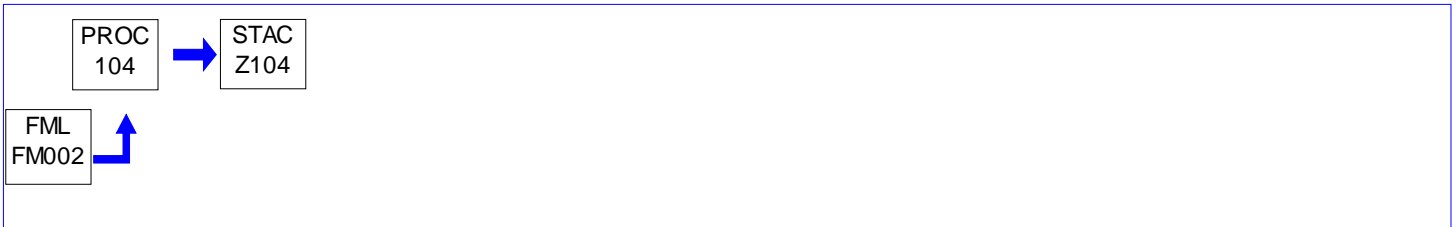
**I. RESTRICTIONS.****Emission Restriction(s).****# 001 [25 Pa. Code §123.21]****General**

No person may permit the emission into the outdoor atmosphere of sulfur oxides from a source in a manner that the concentration of the sulfur oxides, expressed as SO₂, in the effluent gas exceeds 500 parts per million, by volume, dry basis.

002 [25 Pa. Code §127.441]**Operating permit terms and conditions.**

(a) Operation of the above generators shall be limited to 300 hours per year for each generator with total combined NO_x emissions not to exceed 1.0 tpy, based on any consecutive 12-month rolling period.

(b) The permittee shall operate, maintain, and monitor a fuel usage meter on the above generators to measure and record the amount of fuel used on a monthly basis.

II. TESTING REQUIREMENTS.

No additional testing requirements exist except as provided in other sections of this permit including Section B (Title V General Requirements) and/or Section E (Source Group Restrictions).

III. MONITORING REQUIREMENTS.**# 003 [25 Pa. Code §127.441]****Operating permit terms and conditions.**

The permittee shall operate, maintain, and monitor an hour-run-meter on each of the above generators to record the operating time. Records shall be maintained on a monthly basis.

IV. RECORDKEEPING REQUIREMENTS.

No additional record keeping requirements exist except as provided in other sections of this permit including Section B (Title V General Requirements) and/or Section E (Source Group Restrictions).

V. REPORTING REQUIREMENTS.

No additional reporting requirements exist except as provided in other sections of this permit including Section B (Title V General Requirements) and/or Section E (Source Group Restrictions).

**SECTION D. Source Level Requirements****VI. WORK PRACTICE REQUIREMENTS.**

No additional work practice requirements exist except as provided in other sections of this permit including Section B (Title V General Requirements) and/or Section E (Source Group Restrictions).

VII. ADDITIONAL REQUIREMENTS.

No additional requirements exist except as provided in other sections of this permit including Section B (Title V General Requirements) and/or Section E (Source Group Restrictions).

***** Permit Shield in Effect. *****

**SECTION D. Source Level Requirements**

Source ID: 105

Source Name: Y2K EMERGENCY GENERATOR

Source Capacity/Throughput:

Conditions for this source occur in the following groups: GROUP 005

**I. RESTRICTIONS.****Emission Restriction(s).****# 001 [25 Pa. Code §123.21]****General**

No person may permit the emission into the outdoor atmosphere of sulfur oxides from a source in a manner that the concentration of the sulfur oxides, expressed as SO₂, in the effluent gas exceeds 500 parts per million, by volume, dry basis.

002 [25 Pa. Code §127.441]**Operating permit terms and conditions.**

(a) The permittee shall limit the operation of the above emergency generator to no more than 500 hours of operation over any consecutive 12-month rolling period.

(b) The permittee shall operate, maintain, and monitor a fuel usage meter on the above generator to measure and record the amount of fuel used on a monthly basis.

(c) The No. 2 fuel oil used in the above generator shall not exceed 0.5% sulfur by weight.

II. TESTING REQUIREMENTS.

No additional testing requirements exist except as provided in other sections of this permit including Section B (Title V General Requirements) and/or Section E (Source Group Restrictions).

III. MONITORING REQUIREMENTS.**# 003 [25 Pa. Code §127.441]****Operating permit terms and conditions.**

The permittee shall operate, maintain, and monitor the hour-run-meter on the above generator to record the operating time. Records shall be maintained on a monthly basis.

IV. RECORDKEEPING REQUIREMENTS.

No additional record keeping requirements exist except as provided in other sections of this permit including Section B (Title V General Requirements) and/or Section E (Source Group Restrictions).

V. REPORTING REQUIREMENTS.

No additional reporting requirements exist except as provided in other sections of this permit including Section B (Title V General Requirements) and/or Section E (Source Group Restrictions).



SECTION D. Source Level Requirements

VI. WORK PRACTICE REQUIREMENTS.

No additional work practice requirements exist except as provided in other sections of this permit including Section B (Title V General Requirements) and/or Section E (Source Group Restrictions).

VII. ADDITIONAL REQUIREMENTS.

No additional requirements exist except as provided in other sections of this permit including Section B (Title V General Requirements) and/or Section E (Source Group Restrictions).

***** Permit Shield in Effect. *****

**SECTION D. Source Level Requirements**

Source ID: 220

Source Name: DRY MILK PROCESS SYSTEM

Source Capacity/Throughput: 2,712.000 Lbs/HR Dry Milk

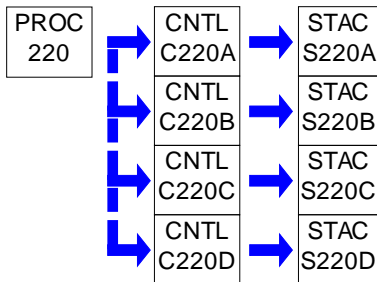
**I. RESTRICTIONS.****Emission Restriction(s).****# 001 [25 Pa. Code §127.441]****Operating permit terms and conditions.**

No person shall permit the emission into the outdoor atmosphere of particulate matter from the above fabric filters (C220A thru C220D) in a manner that the concentration of particulate matter in the effluent gas exceeds 0.02 gr/dscf.

II. TESTING REQUIREMENTS.

No additional testing requirements exist except as provided in other sections of this permit including Section B (Title V General Requirements).

III. MONITORING REQUIREMENTS.**# 002 [25 Pa. Code §127.441]****Operating permit terms and conditions.**

In order to assure compliance with the requirement of Condition #001 above, the permittee shall be required to perform the following:

(1) Monitor and record the pressure drop across each of the above fabric filters (C220A thru C220D) on a daily basis, when operating. A pressure drop range of 0.25 to 10.0 inches of water column shall be used in determining the proper operation of the fabric filters. In the event the pressure drop readings are not within this range, the permittee shall take corrective actions to return the operations of the fabric filter to within the recommended operating range. This prescribed range shall be used to determine proper fabric filter operation at all times when the source is in operation except during:

- (a) The initial break-in period for new collector bags.
- (b) The first 15 minutes during the initial start-up of the source.

(2) Each reading shall be entered in a logbook or a data logging system indicating the date and time the reading was taken, the prescribed operating range, and details of any corrective actions taken. The data shall be maintained at the facility for a period of five (5) years and be made available to the Department upon request.

IV. RECORDKEEPING REQUIREMENTS.

No additional record keeping requirements exist except as provided in other sections of this permit including Section B (Title V General Requirements).



SECTION D. Source Level Requirements

V. REPORTING REQUIREMENTS.

No additional reporting requirements exist except as provided in other sections of this permit including Section B (Title V General Requirements).

VI. WORK PRACTICE REQUIREMENTS.

No additional work practice requirements exist except as provided in other sections of this permit including Section B (Title V General Requirements).

VII. ADDITIONAL REQUIREMENTS.

No additional requirements exist except as provided in other sections of this permit including Section B (Title V General Requirements).

***** Permit Shield in Effect. *****

**SECTION D. Source Level Requirements**

Source ID: 230

Source Name: MILK CRUMB PROCESSING SYSTEM

Source Capacity/Throughput: 5,980.000 Lbs/HR Milk Crumb

Conditions for this source occur in the following groups: GROUP 007

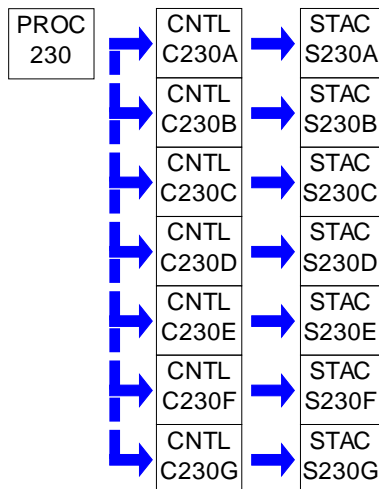
**I. RESTRICTIONS.****Emission Restriction(s).**

001 [25 Pa. Code §127.441]

Operating permit terms and conditions.

No person shall permit the emission into the outdoor atmosphere of particulate matter from each of the above fabric filters (C230A thru C230G) in a manner that the concentration of particulate matter in the effluent gas exceeds 0.02 gr/dscf.

II. TESTING REQUIREMENTS.

No additional testing requirements exist except as provided in other sections of this permit including Section B (Title V General Requirements) and/or Section E (Source Group Restrictions).

III. MONITORING REQUIREMENTS.

No additional monitoring requirements exist except as provided in other sections of this permit including Section B (Title V General Requirements) and/or Section E (Source Group Restrictions).

IV. RECORDKEEPING REQUIREMENTS.

No additional record keeping requirements exist except as provided in other sections of this permit including Section B (Title V General Requirements) and/or Section E (Source Group Restrictions).

V. REPORTING REQUIREMENTS.

No additional reporting requirements exist except as provided in other sections of this permit including Section B (Title V General Requirements) and/or Section E (Source Group Restrictions).



SECTION D. Source Level Requirements

VI. WORK PRACTICE REQUIREMENTS.

No additional work practice requirements exist except as provided in other sections of this permit including Section B (Title V General Requirements) and/or Section E (Source Group Restrictions).

VII. ADDITIONAL REQUIREMENTS.

No additional requirements exist except as provided in other sections of this permit including Section B (Title V General Requirements) and/or Section E (Source Group Restrictions).

***** Permit Shield in Effect. *****

**SECTION D. Source Level Requirements**

Source ID: 240

Source Name: SUGAR STORAGE AND DISTRIBUTION SYSTEM

Source Capacity/Throughput: 3,233.000 Lbs/HR Sugar

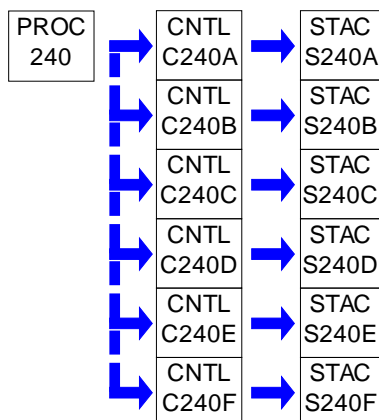
**I. RESTRICTIONS.****Emission Restriction(s).****# 001 [25 Pa. Code §127.441]****Operating permit terms and conditions.**

No person shall permit the emission into the outdoor atmosphere of particulate matter from each of the above fabric filters (C240A thru C240F) in a manner that the concentration of particulate matter in the effluent gas exceeds 0.02 gr/dscf.

II. TESTING REQUIREMENTS.

No additional testing requirements exist except as provided in other sections of this permit including Section B (Title V General Requirements).

III. MONITORING REQUIREMENTS.**# 002 [25 Pa. Code §127.441]****Operating permit terms and conditions.**

In order to assure compliance with the requirement of Condition #001 above, the permittee shall be required to perform the following:

(1) Monitor and record the pressure drop across each of the above fabric filters (C240A thru C240F) on a daily basis, when operating. A pressure drop range of 0.25 to 10.0 inches of water column shall be used in determining the proper operation of the fabric filters. In the event the pressure drop readings are not within this range, the permittee shall take corrective actions to return the operations of the fabric filter to within the recommended operating range. This prescribed range shall be used to determine proper fabric filter operation at all times when the source is in operation except during:

- (a) The initial break-in period for new collector bags.
- (b) The first 15 minutes during the initial start-up of the source.

(2) Each reading shall be entered in a logbook or a data logging system indicating the date and time the reading was taken, the prescribed operating range, and details of any corrective actions taken. The data shall be maintained at the facility for a period of five (5) years and be made available to the Department upon request.



SECTION D. Source Level Requirements

IV. RECORDKEEPING REQUIREMENTS.

No additional record keeping requirements exist except as provided in other sections of this permit including Section B (Title V General Requirements).

V. REPORTING REQUIREMENTS.

No additional reporting requirements exist except as provided in other sections of this permit including Section B (Title V General Requirements).

VI. WORK PRACTICE REQUIREMENTS.

No additional work practice requirements exist except as provided in other sections of this permit including Section B (Title V General Requirements).

VII. ADDITIONAL REQUIREMENTS.

No additional requirements exist except as provided in other sections of this permit including Section B (Title V General Requirements).

***** Permit Shield in Effect. *****

**SECTION D. Source Level Requirements**

Source ID: 401

Source Name: JETZONE #1 BEAN CLEANER/SEPARATOR

Source Capacity/Throughput: 7,986.000 Lbs/HR Cocoa Beans

Conditions for this source occur in the following groups: GROUP 007

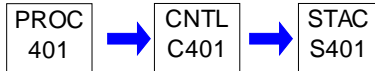
**I. RESTRICTIONS.****Emission Restriction(s).**

001 [25 Pa. Code §127.441]

Operating permit terms and conditions.

No person shall permit the emission into the outdoor atmosphere of particulate matter from the above source in a manner that the concentration of particulate matter in the effluent gas exceeds 0.02 gr/dscf

II. TESTING REQUIREMENTS.

No additional testing requirements exist except as provided in other sections of this permit including Section B (Title V General Requirements) and/or Section E (Source Group Restrictions).

III. MONITORING REQUIREMENTS.

No additional monitoring requirements exist except as provided in other sections of this permit including Section B (Title V General Requirements) and/or Section E (Source Group Restrictions).

IV. RECORDKEEPING REQUIREMENTS.

No additional record keeping requirements exist except as provided in other sections of this permit including Section B (Title V General Requirements) and/or Section E (Source Group Restrictions).

V. REPORTING REQUIREMENTS.

No additional reporting requirements exist except as provided in other sections of this permit including Section B (Title V General Requirements) and/or Section E (Source Group Restrictions).

VI. WORK PRACTICE REQUIREMENTS.

No additional work practice requirements exist except as provided in other sections of this permit including Section B (Title V General Requirements) and/or Section E (Source Group Restrictions).

VII. ADDITIONAL REQUIREMENTS.

No additional requirements exist except as provided in other sections of this permit including Section B (Title V General Requirements) and/or Section E (Source Group Restrictions).

***** Permit Shield in Effect. *****

**SECTION D. Source Level Requirements**

Source ID: 402

Source Name: JETZONE #1 BEAN ROASTER AND COOLER

Source Capacity/Throughput: 7,700.000 Lbs/HR Cocoa Beans
7.200 MCF/HR Natural Gas

Conditions for this source occur in the following groups: GROUP 001
GROUP 007

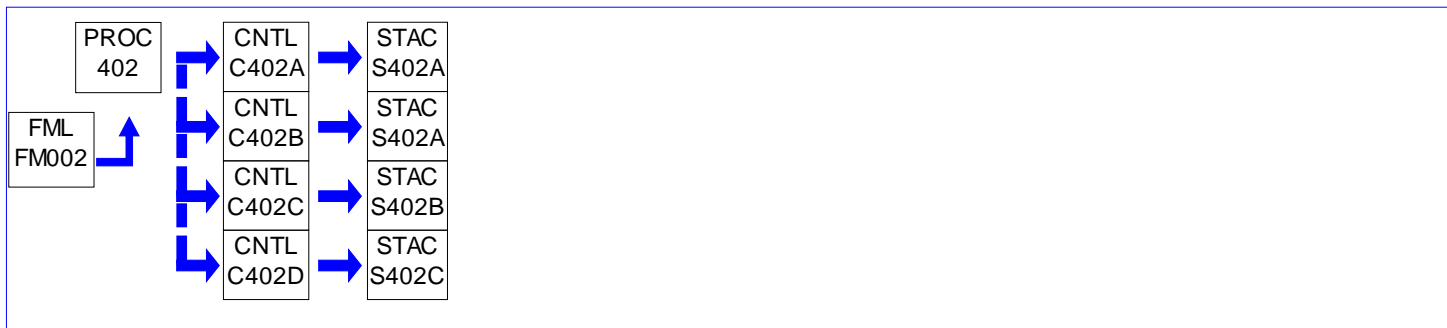
**I. RESTRICTIONS.****Emission Restriction(s).****# 001 [25 Pa. Code §123.13]****Processes**

No person shall permit the emission into the outdoor atmosphere of particulate matter from each of the above cyclones (C402A thru C402D) in a manner that the concentration of particulate matter in the effluent gas exceeds 0.01 gr/dscf.

002 [25 Pa. Code §127.441]**Operating permit terms and conditions.**

The volatile organic compound (VOC) emissions from Source ID #402, shall not exceed 17.04 tons of VOCs, based on a consecutive 12-month rolling period. At this level of emissions, add-on controls were deemed to be cost-ineffective for RACT 2.

II. TESTING REQUIREMENTS.

No additional testing requirements exist except as provided in other sections of this permit including Section B (Title V General Requirements) and/or Section E (Source Group Restrictions).

III. MONITORING REQUIREMENTS.

No additional monitoring requirements exist except as provided in other sections of this permit including Section B (Title V General Requirements) and/or Section E (Source Group Restrictions).

IV. RECORDKEEPING REQUIREMENTS.

No additional record keeping requirements exist except as provided in other sections of this permit including Section B (Title V General Requirements) and/or Section E (Source Group Restrictions).

V. REPORTING REQUIREMENTS.

No additional reporting requirements exist except as provided in other sections of this permit including Section B (Title V General Requirements) and/or Section E (Source Group Restrictions).



SECTION D. Source Level Requirements

VI. WORK PRACTICE REQUIREMENTS.

No additional work practice requirements exist except as provided in other sections of this permit including Section B (Title V General Requirements) and/or Section E (Source Group Restrictions).

VII. ADDITIONAL REQUIREMENTS.

No additional requirements exist except as provided in other sections of this permit including Section B (Title V General Requirements) and/or Section E (Source Group Restrictions).

***** Permit Shield in Effect. *****

**SECTION D. Source Level Requirements**

Source ID: 403

Source Name: JETZONE #1 WINNOWING OPERATIONS

Source Capacity/Throughput: 4,840.000 Lbs/HR Cocoa Beans

Conditions for this source occur in the following groups: GROUP 007

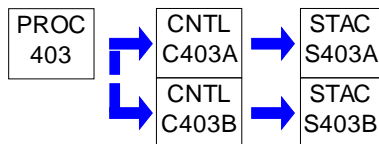
**I. RESTRICTIONS.****Emission Restriction(s).****# 001 [25 Pa. Code §123.13]****Processes**

No person may permit the emission into the outdoor atmosphere of particulate matter from each of the above fabric filters (C403A & C403B) in such a manner that the concentration of particulate matter in the effluent gas exceeds 0.04 grains per dry standard cubic foot, when the effluent gas volume is less than 150,000 dry standard cubic feet per minute.

II. TESTING REQUIREMENTS.

No additional testing requirements exist except as provided in other sections of this permit including Section B (Title V General Requirements) and/or Section E (Source Group Restrictions).

III. MONITORING REQUIREMENTS.

No additional monitoring requirements exist except as provided in other sections of this permit including Section B (Title V General Requirements) and/or Section E (Source Group Restrictions).

IV. RECORDKEEPING REQUIREMENTS.**# 002 [25 Pa. Code §127.441]****Operating permit terms and conditions.**

(a) The permittee shall keep the following records:

- (1) a maintenance log of all scheduled and unscheduled maintenance on the source and/or control device, and
- (2) monthly throughput of cocoa beans.

The records shall be made available to the Department upon request.

V. REPORTING REQUIREMENTS.

No additional reporting requirements exist except as provided in other sections of this permit including Section B (Title V General Requirements) and/or Section E (Source Group Restrictions).

VI. WORK PRACTICE REQUIREMENTS.

No additional work practice requirements exist except as provided in other sections of this permit including Section B (Title V General Requirements) and/or Section E (Source Group Restrictions).

**SECTION D. Source Level Requirements****VII. ADDITIONAL REQUIREMENTS.**

No additional requirements exist except as provided in other sections of this permit including Section B (Title V General Requirements) and/or Section E (Source Group Restrictions).

***** Permit Shield in Effect. *****

**SECTION D. Source Level Requirements**

Source ID: 501

Source Name: JETZONE #2 COCOA BEAN CLEANING

Source Capacity/Throughput: 7,920.000 Lbs/HR Cocoa Beans

Conditions for this source occur in the following groups: GROUP 007

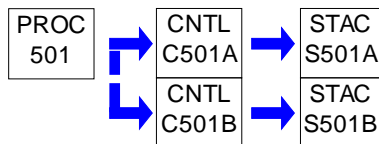
**I. RESTRICTIONS.****Emission Restriction(s).**

001 [25 Pa. Code §123.13]

Processes

No person shall permit the emission into the outdoor atmosphere of particulate matter from each of the above fabric filters (C501A & C501B) in a manner that the concentration of particulate matter in the effluent gas exceeds 0.02 gr/dscf.

II. TESTING REQUIREMENTS.

No additional testing requirements exist except as provided in other sections of this permit including Section B (Title V General Requirements) and/or Section E (Source Group Restrictions).

III. MONITORING REQUIREMENTS.

No additional monitoring requirements exist except as provided in other sections of this permit including Section B (Title V General Requirements) and/or Section E (Source Group Restrictions).

IV. RECORDKEEPING REQUIREMENTS.

002 [25 Pa. Code §127.441]

Operating permit terms and conditions.

The permittee shall keep the following records:

- (1) A maintenance log of all scheduled and unscheduled maintenance on the source and/or control device, and
- (2) Monthly throughput of cocoa beans.

The records shall be made available to the Department upon request.

003 [25 Pa. Code §127.441]

Operating permit terms and conditions.

The permittee shall in accordance with Condition #015 of Section C calculate the VOC emissions for each month and each consecutive 12-month period.

V. REPORTING REQUIREMENTS.

No additional reporting requirements exist except as provided in other sections of this permit including Section B (Title V General Requirements) and/or Section E (Source Group Restrictions).



SECTION D. Source Level Requirements

VI. WORK PRACTICE REQUIREMENTS.

No additional work practice requirements exist except as provided in other sections of this permit including Section B (Title V General Requirements) and/or Section E (Source Group Restrictions).

VII. ADDITIONAL REQUIREMENTS.

No additional requirements exist except as provided in other sections of this permit including Section B (Title V General Requirements) and/or Section E (Source Group Restrictions).

***** Permit Shield in Effect. *****

**SECTION D. Source Level Requirements**

Source ID: 502

Source Name: JETZONE #2 COCOA BEAN ROASTER & COOLER

Source Capacity/Throughput: 7,920.000 Lbs/HR Cocoa Beans
1.780 MCF/HR Natural Gas

Conditions for this source occur in the following groups: GROUP 001

**I. RESTRICTIONS.****Emission Restriction(s).****# 001 [25 Pa. Code §123.13]****Processes**

No person shall permit the emission into the outdoor atmosphere of particulate matter from each of the above cyclones (C502C thru C502E) and wet scrubbers (C502A and C502B) in a manner that the concentration of particulate matter in the effluent gas exceeds 0.02 gr/dscf.

002 [25 Pa. Code §127.441]**Operating permit terms and conditions.**

The Volatile Organic Compound (VOC) emissions from the Jetzone 2 Roaster and Cooler, Source ID 502 and Jetzone 2 Pregrind Liquor Milling Operation, Source ID 504, shall remain less than 48.90 tons of VOC per any consecutive 12 months. At this level of emissions, add-on controls were deemed to be cost-ineffective for RACT 2.

Throughput Restriction(s).**# 003 [25 Pa. Code §127.441]****Operating permit terms and conditions.**

The permittee shall limit the operation of the Jetzone 2 Roaster, Source ID 502 to less than 33,660 tons of cocoa bean throughput per any consecutive 12-month period.

II. TESTING REQUIREMENTS.

No additional testing requirements exist except as provided in other sections of this permit including Section B (Title V General Requirements) and/or Section E (Source Group Restrictions).

III. MONITORING REQUIREMENTS.**# 004 [40 CFR Part 64 Compliance Assurance Monitoring for Major Stationary Sources §40 CFR 64.3]****Sections of PART 64****Monitoring design criteria**

- The permittee shall use the pressure differential across each of the above cyclones and wet scrubbers to obtain data and monitor the emission control equipment performance.
- The permittee shall use the water flow rate to the above wet scrubbers to obtain additional data for monitoring the emission control equipment performance.
- The permittee shall operate and maintain devices to measure the pressure differential across each of the cyclones and wet scrubbers associated with the above source.

**SECTION D. Source Level Requirements**

(d) The permittee shall operate and maintain an electronic flow meter to measure the water flow rate to each of the above wet scrubbers associated with the above source.

(e) The permittee shall monitor the pressure differential across each of the cyclones and wet scrubbers once per day while the above source and respective control devices are operating.

(f) The permittee shall monitor the water flow rate to each of the above scrubbers once per day while the above source and respective control devices are operating.

IV. RECORDKEEPING REQUIREMENTS.**# 005 [40 CFR Part 64 Compliance Assurance Monitoring for Major Stationary Sources §40 CFR 64.9]****Sections of PART 64****Reporting and recordkeeping requirements**

(a) The permittee shall maintain records of the following information:

(1) Daily readings of the pressure differential across each of the above cyclones.

(2) Daily readings of the pressure drop and water flow rate to each of the above wet scrubbers.

(3) The permittee shall record all excursions and corrective actions taken in response to an excursion and the time elapsed until the corrective actions have been taken.

(4) The permittee shall record all inspections, repairs and maintenance performed on the monitoring equipment and control devices.

(5) The permittee shall maintain records of all monitoring equipment down time incidents (other than down time associated with accuracy checks or calibration checks). The permittee shall also record the dates, times and durations, possible causes and corrective actions taken for the incidents.

(b) The permittee shall keep all records for a period of five (5) years and make the records available to the Department upon request.

V. REPORTING REQUIREMENTS.**# 006 [40 CFR Part 64 Compliance Assurance Monitoring for Major Stationary Sources §40 CFR 64.9]****Sections of PART 64****Reporting and recordkeeping requirements**

(a) The permittee shall report all excursions and corrective actions taken, the dates, times, durations and possible causes, every six (6) months.

(b) The permittee shall report all monitoring equipment down time incidents (other than down time associated with accuracy checks or calibration checks), their dates, times and durations, possible causes and corrective actions taken, every six (6) months.

VI. WORK PRACTICE REQUIREMENTS.**# 007 [25 Pa. Code §127.441]****Operating permit terms and conditions.**

(a) The permittee shall annually shutdown the scrubbers (C502A & C502B) to open and inspect the interior for solids deposition, remove as necessary; inspect bearings on the water recirculation pump, exhaust fan and motor, repair and replace as necessary; and inspect access hatches and replace gasketing material as required.

(b) The permittee shall annually shutdown the cyclones (C502C thru C502E) to open and inspect the interior of the cyclones and ductwork for wear, and repair if necessary; inspect the doors and ductwork for leakage, and replace worn gasketing if necessary.

**SECTION D. Source Level Requirements****# 008 [25 Pa. Code §127.441]****Operating permit terms and conditions.**

The permittee shall operate and maintain instrumentation to monitor the pressure drop across the cyclones, C502C, C502D, & C502E, and the pressure drop and water flow rate of the scrubbers C502A & C502B.

009 [40 CFR Part 64 Compliance Assurance Monitoring for Major Stationary Sources §40 CFR 64.6]**Sections of PART 64****Approval of monitoring**

- (a) A range of 0.5 to 10.0 inches of water column shall be used in determining the proper operation of cyclones C502C thru C502E above.
- (b) A range of 1.0 to 7.0 inches of water column and a minimum water flow rate of 20 gpm shall be used in determining the proper operation of wet scrubbers C502A and C502B above.
- (c) The prescribed ranges shall be used to determine proper cyclone and scrubber operations at all times when the source is in operation except during the following:
- (1) The first 15 minutes of an initial start-up of the source.
 - (2) During those times when the roaster is not operating and the grinding mills are operating.
- (d) A departure from the pressure differential drop ranges for the cyclones specified in (a), above, shall be defined as an excursion. Failure to perform a daily pressure differential monitoring shall also be defined as an excursion.
- (e) An excursion has occurred when the daily pressure drop reading across the wet scrubbers goes below 1.0 inches or above 7.0 inches of water column and the daily reading of the water flow rate drops below 20 gpm. Failure to take a daily pressure drop and water flow rate reading shall also be defined as an excursion.
- (f) The permittee shall operate and maintain the appropriate gauges to measure the pressure differential across each of the above cyclones and wet scrubbers, and the appropriate electronic flow monitors for measuring water flow rates to each of the above wet scrubbers.
- (g) The permittee shall check each pressure gauge a minimum of once per year to ensure measurement accuracy within 10%. A pressure gauge that is not operating with a measurement accuracy within 10% shall be replaced or repaired. Results of the annual pressure gauge measurement accuracy checks shall be retained on site for a minimum of five (5) years and be made available to the Department upon request.

VII. ADDITIONAL REQUIREMENTS.**# 010 [40 CFR Part 64 Compliance Assurance Monitoring for Major Stationary Sources §40 CFR 64.8]****Sections of PART 64****Quality improvement plan (QIP) requirements**

- (a) The permittee shall develop and implement a quality improvement plan (QIP) as expeditiously as practicable if any of the following occurs:
- (1) Six excursions for any individual parameter that occurs in a six-month reporting period.
 - (2) The Department determines after review of all reported information that the permittee has not responded acceptably to an excursion.
- (b) The QIP should be developed within 60 days and the permittee shall provide a copy of the QIP to the Department. Furthermore, the permittee shall notify the Department if the period for completing the improvements contained in the QIP exceeds 180 days from the date on which the need to implement the QIP was determined.
- (c) The permittee shall record actions taken to implement the QIP during a reporting period and all related actions including,

**SECTION D. Source Level Requirements**

but not limited to inspections, repairs and maintenance performed on the monitoring equipment.

(d) The QIP shall include procedures for evaluating the control performance problems. Based on the results of the evaluation procedures, the permittee shall modify the QIP, and provide a copy to the Department, to include procedures for conducting more frequent or improved monitoring in conjunction with one or more of the following:

- (1) Improved preventive maintenance practices.
- (2) Process operation changes.
- (3) Appropriate improvements to control methods.
- (4) Other steps appropriate to correct performance.

(e) Following implementation of a QIP, the Department will require reasonable revisions to the QIP if the plan has failed to either:

- (1) Address the cause of the control device performance problem.
- (2) Provide adequate procedures for correcting control device performance problems in as expeditiously as practicable in accordance with good air pollution control practices for minimizing emissions.

(f) Implementation of a QIP shall not excuse the owner or operator of a source from compliance with any existing emission limitation or standard or any existing monitoring, testing, reporting or recordkeeping requirement that may apply under any federal, state, or local laws or any other applicable requirements under the Clean Air Act.

***** Permit Shield in Effect. *****

**SECTION D. Source Level Requirements**

Source ID: 503

Source Name: JETZONE #2 WINNOWER OPERATIONS

Source Capacity/Throughput: 7,920.000 Lbs/HR Cocoa Beans

Conditions for this source occur in the following groups: GROUP 007

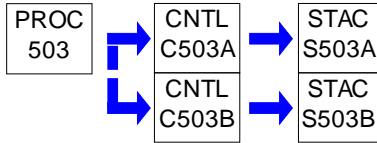
**I. RESTRICTIONS.****Emission Restriction(s).**

001 [25 Pa. Code §123.13]

Processes

No person shall permit the emission into the outdoor atmosphere of particulate matter from the above fabric filters (C503A & C503B) in a manner that the concentration of particulate matter in the effluent gas exceeds 0.02 gr/dscf.

002 [25 Pa. Code §127.441]

Operating permit terms and conditions.

The permittee shall limit the emissions from the above Jetzone 2 Winnower to less than one (1) ton of Volatile Organic Compounds (VOCs) per any consecutive 12-month period.

Throughput Restriction(s).

003 [25 Pa. Code §127.441]

Operating permit terms and conditions.

The permittee shall limit the operation of the above Jetzone 2 Winnower to less than 33,660 tons of cocoa bean throughput per any consecutive 12-month period.

II. TESTING REQUIREMENTS.

No additional testing requirements exist except as provided in other sections of this permit including Section B (Title V General Requirements) and/or Section E (Source Group Restrictions).

III. MONITORING REQUIREMENTS.

No additional monitoring requirements exist except as provided in other sections of this permit including Section B (Title V General Requirements) and/or Section E (Source Group Restrictions).

IV. RECORDKEEPING REQUIREMENTS.

004 [25 Pa. Code §127.441]

Operating permit terms and conditions.

The permittee shall keep records of the monthly throughput of cocoa beans. The records shall be made available to DEP upon request.

005 [25 Pa. Code §127.441]

Operating permit terms and conditions.

The permittee shall in accordance with Condition #015 of Section C calculate the VOC emissions for each month and each consecutive 12-month period.



SECTION D. Source Level Requirements

V. REPORTING REQUIREMENTS.

No additional reporting requirements exist except as provided in other sections of this permit including Section B (Title V General Requirements) and/or Section E (Source Group Restrictions).

VI. WORK PRACTICE REQUIREMENTS.

No additional work practice requirements exist except as provided in other sections of this permit including Section B (Title V General Requirements) and/or Section E (Source Group Restrictions).

VII. ADDITIONAL REQUIREMENTS.

No additional requirements exist except as provided in other sections of this permit including Section B (Title V General Requirements) and/or Section E (Source Group Restrictions).

***** Permit Shield in Effect. *****

**SECTION D. Source Level Requirements**

Source ID: 504

Source Name: JETZONE #2 PREGRIND OPERATIONS

Source Capacity/Throughput: 6,600.000 Lbs/HR Cocoa Beans

Conditions for this source occur in the following groups: GROUP 001

**I. RESTRICTIONS.****Emission Restriction(s).****# 001 [25 Pa. Code §123.13]****Processes**

No person shall permit the emission into the outdoor atmosphere of particulate matter from the above source in a manner that the concentration of particulate matter in the effluent gas exceeds 0.02 gr/dscf..

002 [25 Pa. Code §127.441]**Operating permit terms and conditions.**

The Volatile Organic Compound (VOC) emissions from the Jetzone 2 Roaster and Cooler, Source ID 502 and Jetzone 2 Pregrind Liquor Milling Operation, Source ID 504, shall remain less than 48.90 tons of VOC per any consecutive 12 months. At this level of emissions, add-on controls were deemed to be cost-ineffective for RACT 2.

Throughput Restriction(s).**# 003 [25 Pa. Code §127.441]****Operating permit terms and conditions.**

The permittee shall limit the operation of the Jetzone 2 Pregrind Liquor Milling, Source ID #504, to less than 33,660 tons of cocoa bean throughput per any consecutive 12-month rolling period.

II. TESTING REQUIREMENTS.

No additional testing requirements exist except as provided in other sections of this permit including Section B (Title V General Requirements) and/or Section E (Source Group Restrictions).

III. MONITORING REQUIREMENTS.

No additional monitoring requirements exist except as provided in other sections of this permit including Section B (Title V General Requirements) and/or Section E (Source Group Restrictions).

IV. RECORDKEEPING REQUIREMENTS.

No additional record keeping requirements exist except as provided in other sections of this permit including Section B (Title V General Requirements) and/or Section E (Source Group Restrictions).

V. REPORTING REQUIREMENTS.

No additional reporting requirements exist except as provided in other sections of this permit including Section B (Title V General Requirements) and/or Section E (Source Group Restrictions).

**SECTION D. Source Level Requirements****VI. WORK PRACTICE REQUIREMENTS.**

No additional work practice requirements exist except as provided in other sections of this permit including Section B (Title V General Requirements) and/or Section E (Source Group Restrictions).

VII. ADDITIONAL REQUIREMENTS.

004 [40 CFR Part 64 Compliance Assurance Monitoring for Major Stationary Sources §40 CFR 64.2]

Sections of PART 64**Applicability**

This above source is controlled by the wet scrubber associated with Source ID #502 of Section D of this permit. Therefore, in complying with the CAM requirements as defined under Source ID #502, the above source will also be in compliance with all applicable CAM requirements.

***** Permit Shield in Effect. *****

**SECTION D. Source Level Requirements**

Source ID: 600

Source Name: BUHLER COCOA BEAN ROASTER

Source Capacity/Throughput: 8,000.000 Lbs/HR COCOA BEANS

Conditions for this source occur in the following groups: GROUP 001

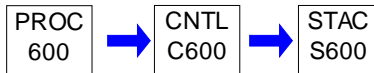
**I. RESTRICTIONS.****Emission Restriction(s).****# 001 [25 Pa. Code §123.13]****Processes**

The permittee may not allow the emission into the outdoor atmosphere of particulate matter from a source in a manner that the concentration of particulate matter in the effluent gas exceeds 0.015 grain per dry standard cubic foot.

002 [25 Pa. Code §123.13]**Processes**

a. No person shall permit the emission into the outdoor atmosphere of visible air contaminants in such a manner that the opacity of the emission is either of the following:

- (1) Equal to or greater than 10% for a period or periods aggregating more than three minutes in any 1 hour.
- (2) Equal to or greater than 30% at any time.

b. The emission limitation shall not apply when:

- (1) The presence of uncombined water is the only reason for failure of the emission to meet the limitation.
- (2) The emission results from the operation of equipment used solely to train and test persons in observing the opacity of visible emissions.
- (3) The emission results from sources specified in Section C, Condition #001.

003 [25 Pa. Code §127.441]**Operating permit terms and conditions.**

The Volatile Organic Compound (VOC) emissions from the Buhler Cocoa Bean Roaster, Source ID 600, shall remain less than 24.4 tons of VOC per any consecutive 12 months. At this level of emissions, add-on controls were deemed to be cost-ineffective for RACT 2.

004 [40 CFR Part 64 Compliance Assurance Monitoring for Major Stationary Sources §40 CFR 64.6]**Sections of PART 64****Approval of monitoring**

(a) A range of 20.0 to 25.0 inches of water column and a water flow rate of 280 to 400 gpm shall be used in determining proper operation of the wet scrubber C600 above.

(b) The prescribed ranges shall be used to determine proper scrubber operations at all times when the source is in operation except during the following:

- (1) The first 15 minutes of an initial start-up of the source.
- (2) During those times when the grinding mills are operating but the roaster is not.

(c) A departure from the pressure differential and water flow rate ranges as defined in paragraph (a) above shall be defined as an excursion. Failure to perform a daily pressure drop and/or a water flow rate reading shall be defined as an excursion.

(d) The permittee shall operate and maintain the appropriate gauges to measure the pressure differential across the wet scrubber, and an appropriate flow monitor for measuring water flow rates to the above wet scrubbers.

(e) The permittee shall check each gauge a minimum of once per year to ensure measurement accuracy within 10%. A pressure gauge that is not operating with a measurement accuracy within 10% shall be replaced or repaired. Results of the

**SECTION D. Source Level Requirements**

annual pressure gauge measurement accuracy checks shall be retained on site for a minimum of five (5) years and be made available to the Department upon request.

(f) The permittee shall maintain spare pressure gauges and related parts on site for routine repairs/replacement.

**# 005 [40 CFR Part 64 Compliance Assurance Monitoring for Major Stationary Sources §40 CFR 64.8]
Sections of PART 64
Quality improvement plan (QIP) requirements**

(a) The permittee shall develop and implement a quality improvement plan (QIP) as expeditiously as practicable if any of the following occurs:

(1) Six excursions for any individual parameter that occurs in a six-month reporting period.

(2) The Department determines after review of all reported information that the permittee has not responded acceptably to an excursion.

(b) The QIP should be developed within 60 days and the permittee shall provide a copy of the QIP to the Department. Furthermore, the permittee shall notify the Department if the period for completing the improvements contained in the QIP exceeds 180 days from the date on which the need to implement the QIP was determined.

(c) The permittee shall record actions taken to implement the QIP during a reporting period and all related actions including, but not limited to inspections, repairs and maintenance performed on the monitoring equipment.

(d) The QIP shall include procedures for evaluating the control performance problems. Based on the results of the evaluation procedures, the permittee shall modify the QIP, and provide a copy to the Department, to include procedures for conducting more frequent or improved monitoring in conjunction with one or more of the following:

- (1) Improved preventive maintenance practices.
- (2) Process operation changes.
- (3) Appropriate improvements to control methods.
- (4) Other steps appropriate to correct performance.

(e) Following implementation of a QIP, the Department will require reasonable revisions to the QIP if the plan has failed to either:

(1) Address the cause of the control device performance problem.

(2) Provide adequate procedures for correcting control device performance problems in as expeditiously as practicable in accordance with good air pollution control practices for minimizing emissions.

(f) Implementation of a QIP shall not excuse the owner or operator of a source from compliance with any existing emission limitation or standard or any existing monitoring, testing, reporting or recordkeeping requirement that may apply under any federal, state, or local laws or any other applicable requirements under the Clean Air Act.

II. TESTING REQUIREMENTS.

No additional testing requirements exist except as provided in other sections of this permit including Section B (Title V General Requirements) and/or Section E (Source Group Restrictions).

III. MONITORING REQUIREMENTS.

**# 006 [40 CFR Part 64 Compliance Assurance Monitoring for Major Stationary Sources §40 CFR 64.3]
Sections of PART 64
Monitoring design criteria**

(a) The permittee shall use the pressure differential across the wet scrubber to obtain data and monitor the emission

**SECTION D. Source Level Requirements**

control equipment performance.

(b) The permittee shall use the water flow rate to the above wet scrubber to obtain additional data for monitoring the emission control equipment performance.

(c) The permittee shall operate and maintain a magnehelic gauge to measure the pressure differential across the wet scrubber associated with the above source.

(d) The permittee shall operate and maintain an electronic flow meter to measure the water flow rate to the wet scrubber associated with the above source.

(e) The permittee shall monitor the pressure differential across the wet scrubber once per day while the above source and respective control devices are operating.

(f) The permittee shall monitor the water flow rate to the above scrubber once per day while the above source and respective control devices are operating.

IV. RECORDKEEPING REQUIREMENTS.**# 007 [40 CFR Part 64 Compliance Assurance Monitoring for Major Stationary Sources §40 CFR 64.9]****Sections of PART 64****Reporting and recordkeeping requirements**

(a) The permittee shall maintain records of the following information:

(1) Daily readings of the pressure differential across the wet scrubber, as well as the weekly averages.

(2) Daily readings of the water flow rate to the above wet scrubber.

(3) The permittee shall record all excursions and corrective actions taken in response to an excursion and the time elapsed until the corrective actions have been taken.

(4) The permittee shall record all inspections, repairs and maintenance performed on the monitoring equipment and scrubber.

(5) The permittee shall maintain records of all monitoring equipment down time incidents (other than down time associated with accuracy checks or calibration checks). The permittee shall also record the dates, times and durations, possible causes and corrective actions taken for the incidents.

(b) The permittee shall keep all records for a period of five (5) years and make the records available to the Department upon request.

V. REPORTING REQUIREMENTS.**# 008 [40 CFR Part 64 Compliance Assurance Monitoring for Major Stationary Sources §40 CFR 64.9]****Sections of PART 64****Reporting and recordkeeping requirements**

(a) The permittee shall report all excursions and corrective actions taken, the dates, times, durations and possible causes, every six (6) months.

(b) The permittee shall report all monitoring equipment down time incidents (other than down time associated with accuracy checks or calibration checks), their dates, times and durations, possible causes and corrective actions taken, every six (6) months.

**SECTION D. Source Level Requirements****VI. WORK PRACTICE REQUIREMENTS.****# 009 [25 Pa. Code §127.441]****Operating permit terms and conditions.**

The permittee shall annually inspect the pumps and valves for leaks and repair as necessary.

VII. ADDITIONAL REQUIREMENTS.

No additional requirements exist except as provided in other sections of this permit including Section B (Title V General Requirements) and/or Section E (Source Group Restrictions).

***** Permit Shield in Effect. *****

**SECTION D. Source Level Requirements**

Source ID: 601

Source Name: WINNOWER

Source Capacity/Throughput: 7,999.000 Lbs/HR COCOA BEANS

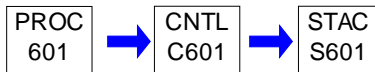
Conditions for this source occur in the following groups: GROUP 002
GROUP 007**I. RESTRICTIONS.****Emission Restriction(s).****# 001 [25 Pa. Code §123.13]****Processes**

The permittee may not allow the emission into the outdoor atmosphere of particulate matter from the above fabric filter (C601) in a manner that the concentration of particulate matter in the effluent gas exceeds 0.02 grain per dry standard cubic foot.

002 [25 Pa. Code §123.13]**Processes**

- a. No person shall permit the emission into the outdoor atmosphere of visible air contaminants in such a manner that the opacity of the emission is either of the following:
- (1) Equal to or greater than 10% for a period or periods aggregating more than three minutes in any 1 hour.
 - (2) Equal to or greater than 30% at any time.
- b. The emission limitation shall not apply when:
- (1) The presence of uncombined water is the only reason for failure of the emission to meet the limitation.
 - (2) The emission results from the operation of equipment used solely to train and test persons in observing the opacity of visible emissions.
 - (3) The emission results from sources specified in Section C, Condition #001

II. TESTING REQUIREMENTS.

No additional testing requirements exist except as provided in other sections of this permit including Section B (Title V General Requirements) and/or Section E (Source Group Restrictions).

III. MONITORING REQUIREMENTS.

No additional monitoring requirements exist except as provided in other sections of this permit including Section B (Title V General Requirements) and/or Section E (Source Group Restrictions).

IV. RECORDKEEPING REQUIREMENTS.

No additional record keeping requirements exist except as provided in other sections of this permit including Section B (Title V General Requirements) and/or Section E (Source Group Restrictions).

V. REPORTING REQUIREMENTS.

No additional reporting requirements exist except as provided in other sections of this permit including Section B (Title V General Requirements) and/or Section E (Source Group Restrictions).



SECTION D. Source Level Requirements

VI. WORK PRACTICE REQUIREMENTS.

No additional work practice requirements exist except as provided in other sections of this permit including Section B (Title V General Requirements) and/or Section E (Source Group Restrictions).

VII. ADDITIONAL REQUIREMENTS.

No additional requirements exist except as provided in other sections of this permit including Section B (Title V General Requirements) and/or Section E (Source Group Restrictions).

***** Permit Shield in Effect. *****

**SECTION D. Source Level Requirements**

Source ID: 602

Source Name: NIB GRINDERS

Source Capacity/Throughput: 6,600.000 Lbs/HR COCOA BEANS

Conditions for this source occur in the following groups: GROUP 001A

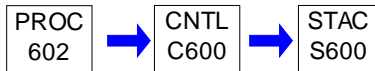
**I. RESTRICTIONS.****Emission Restriction(s).****# 001 [25 Pa. Code §123.13]****Processes**

The permittee may not allow the emission into the outdoor atmosphere of particulate matter from a process in a manner that the concentration of particulate matter in the effluent gas exceeds 0.015 grain per dry standard cubic foot.

002 [25 Pa. Code §123.13]**Processes**

a. No person shall permit the emission into the outdoor atmosphere of visible air contaminants in such a manner that the opacity of the emission is either of the following:

- (1) Equal to or greater than 10% for a period or periods aggregating more than three minutes in any 1 hour.
- (2) Equal to or greater than 30% at any time.

b. The emission limitation shall not apply when:

- (1) The presence of uncombined water is the only reason for failure of the emission to meet the limitation.
- (2) The emission results from the operation of equipment used solely to train and test persons in observing the opacity of visible emissions.
- (3) The emission results from sources specified in Section C, Condition #001

Operation Hours Restriction(s).**# 003 [25 Pa. Code §127.441]****Operating permit terms and conditions.**

The permittee shall limit the operation of the above (Source ID #602) to 8500 hours per year based on any consecutive 12-month period.

II. TESTING REQUIREMENTS.

No additional testing requirements exist except as provided in other sections of this permit including Section B (Title V General Requirements) and/or Section E (Source Group Restrictions).

III. MONITORING REQUIREMENTS.**# 004 [25 Pa. Code §127.441]****Operating permit terms and conditions.**

The permittee shall operate and maintain instrumentation to measure the pressure drop and water flow rate of the scrubber.

IV. RECORDKEEPING REQUIREMENTS.**# 005 [25 Pa. Code §127.441]****Operating permit terms and conditions.**

(a) The permittee shall keep the following records on a monthly basis:

- (1) Hours of operation

**SECTION D. Source Level Requirements**

- (2) Amount of nibs processed, and
- (3) Amount of pollutants emitted, including, PM10 and VOCs.

The permittee shall also calculate and record the above information for each consecutive 12-month period.

These records shall be made available to the Department, upon request.

006 [25 Pa. Code §127.441]**Operating permit terms and conditions.**

(a) The permittee shall weekly, read and record the following information:

- (1) Pressure drop reading across the scrubber, if operating;
- (2) Water flow to the scrubber, if operating.

The permittee shall also keep detailed records of all scheduled and unscheduled maintenance on the scrubber.

These records shall be made available to the Department, upon request.

V. REPORTING REQUIREMENTS.

No additional reporting requirements exist except as provided in other sections of this permit including Section B (Title V General Requirements) and/or Section E (Source Group Restrictions).

VI. WORK PRACTICE REQUIREMENTS.**# 007 [25 Pa. Code §127.441]****Operating permit terms and conditions.**

The permittee shall annually inspect the pumps and valves for leaks and repair as necessary.

VII. ADDITIONAL REQUIREMENTS.

No additional requirements exist except as provided in other sections of this permit including Section B (Title V General Requirements) and/or Section E (Source Group Restrictions).

***** Permit Shield in Effect. *****

**SECTION D. Source Level Requirements**

Source ID: 603

Source Name: BEAN TRANSPORTER

Source Capacity/Throughput: 11,020.000 Lbs/HR COCOA BEANS

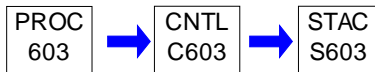
Conditions for this source occur in the following groups: GROUP 002
GROUP 007**I. RESTRICTIONS.****Emission Restriction(s).**

001 [25 Pa. Code §123.13]

Processes

No person shall permit the emission into the outdoor atmosphere of particulate matter from the above fabric filter (C603) in a manner that the concentration of particulate matter in the effluent gas exceeds 0.02 gr/dscf.

II. TESTING REQUIREMENTS.

No additional testing requirements exist except as provided in other sections of this permit including Section B (Title V General Requirements) and/or Section E (Source Group Restrictions).

III. MONITORING REQUIREMENTS.

No additional monitoring requirements exist except as provided in other sections of this permit including Section B (Title V General Requirements) and/or Section E (Source Group Restrictions).

IV. RECORDKEEPING REQUIREMENTS.

No additional record keeping requirements exist except as provided in other sections of this permit including Section B (Title V General Requirements) and/or Section E (Source Group Restrictions).

V. REPORTING REQUIREMENTS.

No additional reporting requirements exist except as provided in other sections of this permit including Section B (Title V General Requirements) and/or Section E (Source Group Restrictions).

VI. WORK PRACTICE REQUIREMENTS.

No additional work practice requirements exist except as provided in other sections of this permit including Section B (Title V General Requirements) and/or Section E (Source Group Restrictions).

VII. ADDITIONAL REQUIREMENTS.

No additional requirements exist except as provided in other sections of this permit including Section B (Title V General Requirements) and/or Section E (Source Group Restrictions).

***** Permit Shield in Effect. *****

**SECTION D. Source Level Requirements**

Source ID: 604

Source Name: FINES/SHELL CONVEYING

Source Capacity/Throughput: 6,600.000 Lbs/HR COCOA BEANS

Conditions for this source occur in the following groups: GROUP 002

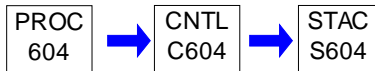
**I. RESTRICTIONS.****Emission Restriction(s).**

001 [25 Pa. Code §123.13]

Processes

No person shall permit the emission into the outdoor atmosphere of particulate matter from the above fabric filter (C604) in a manner that the concentration of particulate matter in the effluent gas exceeds 0.02 gr/dscf.

II. TESTING REQUIREMENTS.

No additional testing requirements exist except as provided in other sections of this permit including Section B (Title V General Requirements) and/or Section E (Source Group Restrictions).

III. MONITORING REQUIREMENTS.

002 [25 Pa. Code §127.441]

Operating permit terms and conditions.

In order to assure compliance with the requirement of Condition #001 above, the permittee shall be required to perform the following:

(1) Monitor and record the pressure drop across the above fabric filter (C604) on a daily basis, when operating. A pressure drop range of 0.25 to 10.0 inches of water column shall be used in determining the proper operation of the fabric filters. In the event the pressure drop readings are not within this range, the permittee shall take corrective actions to return the operations of the fabric filter to within the recommended operating range. This prescribed range shall be used to determine proper fabric filter operation at all times when the source is in operation except during:

- (a) The initial break-in period for new collector bags.
- (b) The first 15 minutes during the initial start-up of the source.

(2) Each reading shall be entered in a logbook or a data logging system indicating the date and time the reading was taken, the prescribed operating range, and details of any corrective actions taken. The data shall be maintained at the facility for a period of five (5) years and be made available to the Department upon request.

IV. RECORDKEEPING REQUIREMENTS.

No additional record keeping requirements exist except as provided in other sections of this permit including Section B (Title V General Requirements) and/or Section E (Source Group Restrictions).

V. REPORTING REQUIREMENTS.

No additional reporting requirements exist except as provided in other sections of this permit including Section B (Title V General Requirements) and/or Section E (Source Group Restrictions).



SECTION D. Source Level Requirements

VI. WORK PRACTICE REQUIREMENTS.

No additional work practice requirements exist except as provided in other sections of this permit including Section B (Title V General Requirements) and/or Section E (Source Group Restrictions).

VII. ADDITIONAL REQUIREMENTS.

No additional requirements exist except as provided in other sections of this permit including Section B (Title V General Requirements) and/or Section E (Source Group Restrictions).

***** Permit Shield in Effect. *****

**SECTION E. Source Group Restrictions.**

Group Name: GROUP 001

Group Description: VOC RACT2 Case Specific Requirements

Sources included in this group

ID	Name
402	JETZONE #1 BEAN ROASTER AND COOLER
502	JETZONE #2 COCOA BEAN ROASTER & COOLER
504	JETZONE #2 PREGRIND OPERATIONS
600	BUHLER COCOA BEAN ROASTER

I. RESTRICTIONS.**Emission Restriction(s).****# 001 [25 Pa. Code §129.96]****Applicability**

(a) For Source 600, the permittee shall operate and maintain the source and control device such that either the scrubber achieves a minimum of 80.0% destruction efficiency for VOC, reported as propane, or the emission rate coming from the scrubber is less than 5.74 lbs/hr of VOCs.

(b) For each of sources 402, 502, 504 and 600, the permittee shall maintain an O&M Plan, as well as records of any maintenance or modifications performed on the source. The permittee shall maintain written documentation of the current O&M Plan for each source and any maintenance or modifications performed on each source for five years. The records shall be made available to the Department upon written request pursuant to 25 Pa. Code §129.100(d) and (i).

(c) The permittee shall operate the Control C502A [JETZONE #2 ROASTER SCRUBBER ZONE #1 (A101)] and C502B: [JETZONE #2 ROASTER SCRUBBER ZONE #1 (A101)] at all times when either of Sources 502 or 504 are operating.

(d) The permittee shall operate the Control C600 [ROASTER WET SCRUBBER] at all times when Source 600 is operating.

(e) The permittee shall operate and maintain instrumentation to monitor the pressure drop and the water flow rate to the scrubbers C502A, C502B and C600.

(f) The permittee shall keep the following records, which shall be maintained for a minimum of five (5) years, and shall be made available to the Department upon request.

(1) a daily record of the pressure drop across and the water flow rate to the scrubbers C502A, C502B and C600.

(2) monthly throughput of cocoa beans.

(3) the VOC emissions for each month and each consecutive 12-month period.

II. TESTING REQUIREMENTS.

No additional testing requirements exist except as provided in other sections of this permit including Section B (Title V General Requirements).

III. MONITORING REQUIREMENTS.

No additional monitoring requirements exist except as provided in other sections of this permit including Section B (Title V General Requirements).

IV. RECORDKEEPING REQUIREMENTS.

No additional record keeping requirements exist except as provided in other sections of this permit including Section B (Title V General Requirements).

V. REPORTING REQUIREMENTS.

No additional reporting requirements exist except as provided in other sections of this permit including Section B (Title V General Requirements).



SECTION E. Source Group Restrictions.

VI. WORK PRACTICE REQUIREMENTS.

No additional work practice requirements exist except as provided in other sections of this permit including Section B (Title V General Requirements).

VII. ADDITIONAL REQUIREMENTS.

No additional requirements exist except as provided in other sections of this permit including Section B (Title V General Requirements).

***** Permit Shield in Effect. *****

**SECTION E. Source Group Restrictions.**

Group Name: GROUP 001A

Group Description: Presumptive RACT 2 Requirements

Sources included in this group

ID	Name
031	BABCOCK & WILCOX BOILER
032	NEBRASKA BOILER
602	NIB GRINDERS

I. RESTRICTIONS.

No additional requirements exist except as provided in other sections of this permit including Section B (Title V General Requirements).

II. TESTING REQUIREMENTS.

No additional testing requirements exist except as provided in other sections of this permit including Section B (Title V General Requirements).

III. MONITORING REQUIREMENTS.

No additional monitoring requirements exist except as provided in other sections of this permit including Section B (Title V General Requirements).

IV. RECORDKEEPING REQUIREMENTS.

No additional record keeping requirements exist except as provided in other sections of this permit including Section B (Title V General Requirements).

V. REPORTING REQUIREMENTS.

No additional reporting requirements exist except as provided in other sections of this permit including Section B (Title V General Requirements).

VI. WORK PRACTICE REQUIREMENTS.**# 001 [25 Pa. Code §129.97]****Presumptive RACT requirements, RACT emission limitations and petition for alternative compliance schedule.**

The permittee shall install, maintain and operate the sources in this Group, and in Item 002 in Section H, in accordance with the manufacturer's specifications and with good operating practices.

VII. ADDITIONAL REQUIREMENTS.

No additional requirements exist except as provided in other sections of this permit including Section B (Title V General Requirements).

***** Permit Shield in Effect. *****

**SECTION E. Source Group Restrictions.**

Group Name: GROUP 002

Group Description: Particulate Sources

Sources included in this group

ID	Name
601	WINNOWER
603	BEAN TRANSPORTER
604	FINES/SHELL CONVEYING

I. RESTRICTIONS.**Emission Restriction(s).****# 001 [25 Pa. Code §127.441]****Operating permit terms and conditions.**

(a) The permittee may not allow the emission into the outdoor atmosphere of particulate matter from a process in this group in a manner that the concentration of particulate matter in the effluent gas exceeds 0.02 grain per dry standard cubic foot.

(b) The permittee shall limit the operation of each of the above sources (Source ID #601, #603, #604, and #605) to 8500 hours per year based on any consecutive 12-month rolling period.

(c) No person shall permit the emission into the outdoor atmosphere of visible air contaminants in such a manner that the opacity of the emission is either of the following:

(1) Equal to or greater than 10% for a period or periods aggregating more than three minutes in any 1 hour.

(2) Equal to or greater than 30% at any time.

(d) The emission limitation shall not apply when:

(1) The presence of uncombined water is the only reason for failure of the emission to meet the limitation.

(2) The emission results from the operation of equipment used solely to train and test persons in observing the opacity of visible emissions.

(3) The emission results from sources specified in Section C, Condition #001.

II. TESTING REQUIREMENTS.

No additional testing requirements exist except as provided in other sections of this permit including Section B (Title V General Requirements).

III. MONITORING REQUIREMENTS.**# 002 [25 Pa. Code §127.441]****Operating permit terms and conditions.**

The permittee shall operate and maintain easily accessible and/or viewable instrumentation to measure pressure drop across the fabric filters.

IV. RECORDKEEPING REQUIREMENTS.**# 003 [25 Pa. Code §127.441]****Operating permit terms and conditions.**

(a) The permittee shall also keep detailed records of all scheduled and unscheduled maintenance on the fabric filters. Maintenance includes, but is not limited to bag change out.

(b) The permittee shall keep the following records on a monthly basis:

(1) Hours of operation

**SECTION E. Source Group Restrictions.**

- (2) Amount of materials processed, and
(3) Amount of pollutants emitted, including, PM10 & VOCs.
- (c) The permittee shall also calculate and record the above information for each consecutive 12 month rolling period.

Note: The above records shall be made available to the Department, upon request.

V. REPORTING REQUIREMENTS.

No additional reporting requirements exist except as provided in other sections of this permit including Section B (Title V General Requirements).

VI. WORK PRACTICE REQUIREMENTS.

004 [25 Pa. Code §127.441]

Operating permit terms and conditions.

The permittee shall annually inspect bags and replace as needed, inspect and clean air chamber, inspect shaft bearings, fan motor, fan exhaust and access doors for air leakage and gaskets and repair as necessary.

VII. ADDITIONAL REQUIREMENTS.

No additional requirements exist except as provided in other sections of this permit including Section B (Title V General Requirements).

***** Permit Shield in Effect. *****

**SECTION E. Source Group Restrictions.**

Group Name: GROUP 003

Group Description: Boiler NOx Requirements

Sources included in this group

ID	Name
031	BABCOCK & WILCOX BOILER
032	NEBRASKA BOILER

I. RESTRICTIONS.**Emission Restriction(s).****# 001 [25 Pa. Code §127.441]****Operating permit terms and conditions.**

(1) The total combined annual fuel input of natural gas and No. 2 fuel oil to the above boilers shall be limited to 3.96×10^5 mmbtu per year with maximum NOx emissions not to exceed 28 tpy, based on any consecutive 12-month rolling period.

(2) The permittee shall not permit the emission of particulate matter from each of the above boilers at a rate determined by the following formula:

$$A = 3.6E(-0.56)$$

Where:

A = Allowable emissions in lbs/mmbtu of heat input.

E = Heat input to the boiler in mmbtu per hour.

(3) Each of the above boilers shall not emit into the outdoor atmosphere sulfur oxides, expressed as SO₂, in excess of 4.0 lbs/mmbtu of heat input over any 1-hour period.

(4) The use of No. 2 fuel oil in each of the above boilers shall not exceed 15 ppm (0.0015%) sulfur by weight.

II. TESTING REQUIREMENTS.

No additional testing requirements exist except as provided in other sections of this permit including Section B (Title V General Requirements).

III. MONITORING REQUIREMENTS.**# 002 [25 Pa. Code §127.441]****Operating permit terms and conditions.**

The permittee shall operate and maintain fuel usage meters to measure and record the amount of each fuel used on a monthly basis.

IV. RECORDKEEPING REQUIREMENTS.**# 003 [25 Pa. Code §127.441]****Operating permit terms and conditions.**

(a) The company shall maintain a permanently bound log book or a data logging system. This log or data logging system shall contain, at a minimum, the following information:

- (1) The date of the tuning procedure.
- (2) The name of the service company and technicians.
- (3) The final operating rate or load.
- (4) The final CO and NOx emission rates.
- (5) The final excess oxygen rate.

**SECTION E. Source Group Restrictions.****V. REPORTING REQUIREMENTS.****# 004 [25 Pa. Code §127.441]****Operating permit terms and conditions.**

A report of the annual adjustment/tune-up shall be submitted to the Reading District Supervisor. Each report (January 1 through December 31) is due no later than March 1 of the following year for each operating year authorized by the operating permit or its renewal.

VI. WORK PRACTICE REQUIREMENTS.**# 005 [25 Pa. Code §127.441]****Operating permit terms and conditions.**

(a) The permittee shall perform an annual adjustment and/or tune-up on each of the boilers which shall include the following:

- (1) Inspection, adjustment, cleaning or replacement of fuel-burning equipment, including the burners and moving parts necessary for proper operation as specified by the manufacturer.
- (2) Inspection of the flame pattern or characteristics and adjustments necessary to minimize emissions of NO_x, and to the extent practicable minimize emissions of CO.
- (3) Inspection of the air-to-fuel ratio control system and adjustments necessary to ensure proper calibration and operation as specified by the manufacturer.

(b) The annual adjustment shall be in accordance with the EPA document "Combustion Efficiency Optimization Manual for Operators of Oil and Gas-Fired Boilers," September 1983 (EPA-340/1-83-023) or equivalent procedures approved in writing by the Department.

VII. ADDITIONAL REQUIREMENTS.

No additional requirements exist except as provided in other sections of this permit including Section B (Title V General Requirements).

***** Permit Shield in Effect. *****

**SECTION E. Source Group Restrictions.**

Group Name: GROUP 004

Group Description: Boiler MACT Requirements, Subpart JJJJJ

Sources included in this group

ID	Name
031	BABCOCK & WILCOX BOILER
032	NEBRASKA BOILER

I. RESTRICTIONS.

No additional requirements exist except as provided in other sections of this permit including Section B (Title V General Requirements).

II. TESTING REQUIREMENTS.

No additional testing requirements exist except as provided in other sections of this permit including Section B (Title V General Requirements).

III. MONITORING REQUIREMENTS.

No additional monitoring requirements exist except as provided in other sections of this permit including Section B (Title V General Requirements).

IV. RECORDKEEPING REQUIREMENTS.

No additional record keeping requirements exist except as provided in other sections of this permit including Section B (Title V General Requirements).

V. REPORTING REQUIREMENTS.

No additional reporting requirements exist except as provided in other sections of this permit including Section B (Title V General Requirements).

VI. WORK PRACTICE REQUIREMENTS.

No additional work practice requirements exist except as provided in other sections of this permit including Section B (Title V General Requirements).

VII. ADDITIONAL REQUIREMENTS.

001 [40 CFR Part 63 NESHAPS for Source Categories §40 CFR 63.11196]

SUBPART JJJJJ - National Emission Standards for Hazardous Air Pollutants for Industrial, Commercial, and Institutional Boilers Area Sources
What are my compliance dates?

The above boilers are exempt from Subpart JJJJJ as long as the units burn gaseous fuels that are not combined with any solid fuels and burn liquid fuel only during periods of gas curtailment, gas supply interruption, startups, or for periodic testing, maintenance, or operator training on liquid fuel. Periodic testing, maintenance, or operator training on liquid fuel shall not exceed a combined total of 48 hours during any calendar year.

***** Permit Shield in Effect. *****

**SECTION E. Source Group Restrictions.**

Group Name: GROUP 005

Group Description: 40 CFR Part 63, Subpart ZZZZ

Sources included in this group

ID	Name
103	DIESEL FIRE PUMP
104	(3) EMERGENCY GENERATORS
105	Y2K EMERGENCY GENERATOR

I. RESTRICTIONS.

No additional requirements exist except as provided in other sections of this permit including Section B (Title V General Requirements).

II. TESTING REQUIREMENTS.

No additional testing requirements exist except as provided in other sections of this permit including Section B (Title V General Requirements).

III. MONITORING REQUIREMENTS.

No additional monitoring requirements exist except as provided in other sections of this permit including Section B (Title V General Requirements).

IV. RECORDKEEPING REQUIREMENTS.

No additional record keeping requirements exist except as provided in other sections of this permit including Section B (Title V General Requirements).

V. REPORTING REQUIREMENTS.

No additional reporting requirements exist except as provided in other sections of this permit including Section B (Title V General Requirements).

VI. WORK PRACTICE REQUIREMENTS.

No additional work practice requirements exist except as provided in other sections of this permit including Section B (Title V General Requirements).

VII. ADDITIONAL REQUIREMENTS.**# 001 [40 CFR Part 63 NESHAPS for Source Categories §40 CFR 63.6585]****Subpart ZZZZ - National Emissions Standards for Hazardous Air Pollutants for Stationary Reciprocating Internal Combustion Engines****Am I subject to this subpart?**

§ 63.6585 Am I subject to this subpart?

You are subject to this subpart if you own or operate a stationary RICE at a major or area source of HAP emissions, except if the stationary RICE is being tested at a stationary RICE test cell/stand.

(a) A stationary RICE is any internal combustion engine which uses reciprocating motion to convert heat energy into mechanical work and which is not mobile. Stationary RICE differ from mobile RICE in that a stationary RICE is not a non-road engine as defined at 40 CFR 1068.30, and is not used to propel a motor vehicle or a vehicle used solely for competition.

(b) A major source of HAP emissions is a plant site that emits or has the potential to emit any single HAP at a rate of 10 tons (9.07 megagrams) or more per year or any combination of HAP at a rate of 25 tons (22.68 megagrams) or more per year, except that for oil and gas production facilities, a major source of HAP emissions is determined for each surface site.

(c) An area source of HAP emissions is a source that is not a major source.

**SECTION E. Source Group Restrictions.**

(d) If you are an owner or operator of an area source subject to this subpart, your status as an entity subject to a standard or other requirements under this subpart does not subject you to the obligation to obtain a permit under 40 CFR part 70 or 71, provided you are not required to obtain a permit under 40 CFR 70.3(a) or 40 CFR 71.3(a) for a reason other than your status as an area source under this subpart. Notwithstanding the previous sentence, you must continue to comply with the provisions of this subpart as applicable.

(e) [NA – NOT USED FOR NATIONAL SECURITY PURPOSES]

(f) [NA – RICE NOT RESIDENTIAL, COMMERCIAL OR INSTITUTIONAL]

[69 FR 33506, June 15, 2004, as amended at 73 FR 3603, Jan. 18, 2008; 78 FR 6700, Jan. 30, 2013]

§ 63.6590 What parts of my plant does this subpart cover?

This subpart applies to each affected source.

(a) Affected source. An affected source is any existing, new, or reconstructed stationary RICE located at a major or area source of HAP emissions, excluding stationary RICE being tested at a stationary RICE test cell/stand.

(1) Existing stationary RICE.

(i) [NA – NOT A MAJOR HAP SOURCE]

(ii) [NA – NOT A MAJOR HAP SOURCE]

(iii) For stationary RICE located at an area source of HAP emissions, a stationary RICE is existing if you commenced construction or reconstruction of the stationary RICE before June 12, 2006.

(iv) A change in ownership of an existing stationary RICE does not make that stationary RICE a new or reconstructed stationary RICE.

(2) New stationary RICE.

(i) [NA – NOT A MAJOR HAP SOURCE]

(ii) [NA – NOT A MAJOR HAP SOURCE]

(iii) [NA - NOT A NEW SOURCE]

(3) [NA – NOT A RECONSTRUCTED SOURCE]

(b) Stationary RICE subject to limited requirements. (1) An affected source which meets either of the criteria in paragraphs (b)(1)(i) through (ii) of this section does not have to meet the requirements of this subpart and of subpart A of this part except for the initial notification requirements of § 63.6645(f).

(i) [NA – NOT A MAJOR HAP SOURCE]

(ii) [NA – NOT A MAJOR HAP SOURCE]

(2) [NA – NOT A MAJOR HAP SOURCE AND DOES NOT COMBUST LFG]

(3) The following stationary RICE do not have to meet the requirements of this subpart and of subpart A of this part, including initial notification requirements:

(i) [NA – NOT A MAJOR HAP SOURCE]

(ii) [NA – NOT A MAJOR HAP SOURCE]

**SECTION E. Source Group Restrictions.**

(iii) [NA – NOT A MAJOR HAP SOURCE]

(iv) [NA – NOT A MAJOR HAP SOURCE]

(v) [NA – NOT A MAJOR HAP SOURCE AND DOES NOT COMBUST LFG]

(c) [NA – NOT SUBJECT TO SUBPARTS IIII OR JJJJ]

[69 FR 33506, June 15, 2004, as amended at 73 FR 3604, Jan. 18, 2008; 75 FR 9674, Mar. 3, 2010; 75 FR 37733, June 30, 2010; 75 FR 51588, Aug. 20, 2010; 78 FR 6700, Jan. 30, 2013]

§ 63.6595 When do I have to comply with this subpart?

(a) Affected sources. (1) If you have an existing stationary RICE, excluding existing non-emergency CI stationary RICE, with a site rating of more than 500 brake HP located at a major source of HAP emissions, you must comply with the applicable emission limitations, operating limitations and other requirements no later than June 15, 2007. IF YOU HAVE an existing non-emergency CI stationary RICE with a site rating of more than 500 brake HP located at a major source of HAP emissions, an existing stationary CI RICE with a site rating of less than or equal to 500 brake HP located at a major source of HAP emissions, or AN EXISTING STATIONARY CI RICE LOCATED AT AN AREA SOURCE OF HAP EMISSIONS, YOU MUST COMPLY WITH THE APPLICABLE EMISSION LIMITATIONS, OPERATING LIMITATIONS, AND OTHER REQUIREMENTS NO LATER THAN MAY 3, 2013.

IF YOU HAVE an existing stationary SI RICE with a site rating of less than or equal to 500 brake HP located at a major source of hap emissions, or AN EXISTING STATIONARY SI RICE LOCATED AT AN AREA SOURCE OF HAP EMISSIONS, YOU MUST COMPLY WITH THE APPLICABLE EMISSION LIMITATIONS, OPERATING LIMITATIONS, AND OTHER REQUIREMENTS NO LATER THAN OCTOBER 19, 2013.

(2) [NA – NOT A MAJOR HAP SOURCE]

(3) [NA – NOT A MAJOR HAP SOURCE]

(4) [NA – NOT A MAJOR HAP SOURCE]

(5) [NA – NOT A MAJOR HAP SOURCE]

(6) [NA – NOT SUBJECT TO EMISSION OR OPERATING LIMITATIONS]

(7) [NA – NOT SUBJECT TO EMISSION OR OPERATING LIMITATIONS]

(b) Area sources that become major sources. If you have an area source that increases its emissions or its potential to emit such that it becomes a major source of HAP, the compliance dates in paragraphs (b)(1) and (2) of this section apply to you.

(1) Any stationary RICE for which construction or reconstruction is commenced after the date when your area source becomes a major source of HAP must be in compliance with this subpart upon startup of your affected source.

(2) Any stationary RICE for which construction or reconstruction is commenced before your area source becomes a major source of HAP must be in compliance with the provisions of this subpart that are applicable to RICE located at major sources within 3 years after your area source becomes a major source of HAP.

(c) If you own or operate an affected source, you must meet the applicable notification requirements in § 63.6645 and in 40 CFR part 63, subpart A.

[69 FR 33506, June 15, 2004, as amended at 73 FR 3604, Jan. 18, 2008; 75 FR 9675, Mar. 3, 2010; 75 FR 51589, Aug. 20, 2010; 78 FR 6701, Jan. 30, 2013]

Emission and Operating Limitations

**SECTION E. Source Group Restrictions.**

§ 63.6600 What emission limitations and operating limitations must I meet if I own or operate a stationary RICE with a site rating of more than 500 brake HP located at a major source of HAP emissions?

[NA – NOT SUBJECT TO EMISSION OR OPERATING LIMITATIONS]

§ 63.6601 What emission limitations must I meet if I own or operate a new or reconstructed 4SLB stationary RICE with a site rating of greater than or equal to 250 brake HP and less than or equal to 500 brake HP located at a major source of HAP emissions?

[NA – NOT SUBJECT TO EMISSION OR OPERATING LIMITATIONS]

§ 63.6602 What emission limitations and other requirements must I meet if I own or operate an existing stationary RICE with a site rating of equal to or less than 500 brake HP located at a major source of HAP emissions?

[NA – NOT SUBJECT TO EMISSION OR OPERATING LIMITATIONS]

§ 63.6603 What emission limitations, operating limitations, and other requirements must I meet if I own or operate an existing stationary RICE located at an area source of HAP emissions?

Compliance with the numerical emission limitations established in this subpart is based on the results of testing the average of three 1-hour runs using the testing requirements and procedures in § 63.6620 and Table 4 to this subpart.

(a) If you own or operate an existing stationary RICE located at an area source of HAP emissions, YOU MUST COMPLY WITH THE REQUIREMENTS IN TABLE 2d to this subpart and the operating limitations in Table 2b to this subpart that apply to you.

TABLE 2d REQUIREMENTS:

4. For each EMERGENCY STATIONARY CI RICE and black start stationary CI RICE**, you must meet the following requirement, except during periods of startup:

- a. Change oil and filter every 500 hours of operation or annually, whichever comes first*;
- b. Inspect air cleaner every 1,000 hours of operation or annually, whichever comes first, and replace as necessary; and
- c. Inspect all hoses and belts every 500 hours of operation or annually, whichever comes first, and replace as necessary.

5. For each EMERGENCY STATIONARY SI RICE; black start stationary SI RICE; non-emergency, non-black start 4SLB stationary RICE >500 HP that operate 24 hours or less per calendar year; non-emergency, non-black start 4SRB stationary RICE >500 HP that operate 24 hours or less per calendar year**, you must meet the following requirement, except during periods of startup:

- a. Change oil and filter every 500 hours of operation or annually, whichever comes first*;
- b. Inspect spark plugs every 1,000 hours of operation or annually, whichever comes first, and replace as necessary; and
- c. Inspect all hoses and belts every 500 hours of operation or annually, whichever comes first, and replace as necessary.

*Sources have the option to utilize an oil analysis program as described in § 63.6625(i) or (j) in order to extend the specified oil change requirement in Table 2d of this subpart.

**If an emergency engine is operating during an emergency and it is not possible to shut down the engine in order to perform the management practice requirements on the schedule required in Table 2d of this subpart, or if performing the management practice on the required schedule would otherwise pose an unacceptable risk under federal, state, or local law, the management practice can be delayed until the emergency is over or the unacceptable risk under federal, state, or local law has abated. The management practice should be performed as soon as practicable after the emergency has ended or the unacceptable risk under federal, state, or local law has abated. Sources must report any failure to perform the

**SECTION E. Source Group Restrictions.**

management practice on the schedule required and the federal, state or local law under which the risk was deemed unacceptable.

[END OF TABLE 2d REQUIREMENTS]

(b) [NA – EMERGENCY ENGINE(S)]

(c) [NA – EMERGENCY ENGINE(S)]

(d) [NA – EMERGENCY ENGINE(S)]

(e) [NA – EMERGENCY ENGINE(S)]

(f) [NA – EMERGENCY ENGINE(S)]

[75 FR 9675, Mar. 3, 2010, as amended at 75 FR 51589, Aug. 20, 2010; 76 FR 12866, Mar. 9, 2011; 78 FR 6701, Jan. 30, 2013]

§ 63.6604 What fuel requirements must I meet if I own or operate a stationary CI RICE?

(a) [NA – EMERGENCY ENGINE(S)]

(b) Beginning January 1, 2015, if you own or operate an existing emergency CI stationary RICE with a site rating of more than 100 brake HP and a displacement of less than 30 liters per cylinder that uses diesel fuel and operates or is contractually obligated to be available for more than 15 hours per calendar year for the purposes specified in § 63.6640(f)(2)(ii) and (iii) or that operates for the purpose specified in § 63.6640(f)(4)(ii), you must use diesel fuel that meets the requirements in 40 CFR 1090.305 for nonroad diesel fuel, except that any existing diesel fuel purchased (or otherwise obtained) prior to January 1, 2015, may be used until depleted.

(c) [NA – NOT A MAJOR SOURCE]

(d) [NA – NOT IN SPECIFIED GEOGRAPHIC LOCATIONS]

[78 FR 6702, Jan. 30, 2013, as amended at 85 FR 78463, Dec. 4, 2020]

General Compliance Requirements

§ 63.6605 What are my general requirements for complying with this subpart?

(a) You must be in compliance with the emission limitations, operating limitations, and other requirements in this subpart that apply to you at all times.

(b) At all times you must operate and maintain any affected source, including associated air pollution control equipment and monitoring equipment, in a manner consistent with safety and good air pollution control practices for minimizing emissions. The general duty to minimize emissions does not require you to make any further efforts to reduce emissions if levels required by this standard have been achieved. Determination of whether such operation and maintenance procedures are being used will be based on information available to the Administrator which may include, but is not limited to, monitoring results, review of operation and maintenance procedures, review of operation and maintenance records, and inspection of the source.

[75 FR 9675, Mar. 3, 2010, as amended at 78 FR 6702, Jan. 30, 2013]

Testing and Initial Compliance Requirements

§ 63.6610 By what date must I conduct the initial performance tests or other initial compliance demonstrations if I own or operate a stationary RICE with a site rating of more than 500 brake HP located at a major source of HAP emissions?

**SECTION E. Source Group Restrictions.**

[NA – NOT A MAJOR HAP SOURCE]

§ 63.6611 By what date must I conduct the initial performance tests or other initial compliance demonstrations if I own or operate a new or reconstructed 4SLB SI stationary RICE with a site rating of greater than or equal to 250 and less than or equal to 500 brake HP located at a major source of HAP emissions?

[NA – NOT A MAJOR HAP SOURCE]

§ 63.6612 By what date must I conduct the initial performance tests or other initial compliance demonstrations if I own or operate an existing stationary RICE with a site rating of less than or equal to 500 brake HP located at a major source of HAP emissions or an existing stationary RICE located at an area source of HAP emissions?

[NA – NO PERFORMANCE TESTING REQUIRED]

§ 63.6615 When must I conduct subsequent performance tests?

[NA – NOT SUBJECT TO EMISSION OR OPERATING LIMITATIONS]

§ 63.6620 What performance tests and other procedures must I use?

[NA – NO PERFORMANCE TESTING REQUIRED]

§ 63.6625 What are my monitoring, installation, collection, operation, and maintenance requirements?

(a) [NA – CEMS NOT REQUIRED]

(b) [NA – CPMS NOT REQUIRED]

(c) [NA – LFG NOT USED]

(d) [NA – NOT A MAJOR HAP SOURCE]

(e) If you own or operate any of the following stationary RICE, you must operate and maintain the stationary RICE and after-treatment control device (if any) according to the manufacturer's emission-related written instructions or develop your own maintenance plan which must provide to the extent practicable for the maintenance and operation of the engine in a manner consistent with good air pollution control practice for minimizing emissions:

(1) [NA – NOT A MAJOR HAP SOURCE]

(2) [NA – NOT A MAJOR HAP SOURCE]

(3) An existing emergency or black start stationary RICE located at an area source of HAP emissions;

(4) [NA – EMERGENCY ENGINE(S)]

(5) [NA – EMERGENCY ENGINE(S)]

(6) [NA – EMERGENCY ENGINE(S)]

(7) [NA – EMERGENCY ENGINE(S)]

(8) [NA – EMERGENCY ENGINE(S)]

(9) [NA – EMERGENCY ENGINE(S)]

(10) [NA – EMERGENCY ENGINE(S)]

**SECTION E. Source Group Restrictions.**

(f) If you own or operate an existing emergency stationary RICE with a site rating of less than or equal to 500 brake HP located at a major source of HAP emissions or an existing emergency stationary RICE located at an area source of HAP emissions, you must install a non-resettable hour meter if one is not already installed.

(g) [NA – EMERGENCY ENGINE(S)]

(h) If you operate a new, reconstructed, or existing stationary engine, you must minimize the engine's time spent at idle during startup and minimize the engine's startup time to a period needed for appropriate and safe loading of the engine, not to exceed 30 minutes, after which time the emission standards applicable to all times other than startup in Tables 1a, 2a, 2c, and 2d to this subpart apply.

(i) If you own or operate a stationary CI engine that is subject to the work, operation or management practices in items 1 or 2 of Table 2c to this subpart or in items 1 or 4 of Table 2d to this subpart, you have the option of utilizing an oil analysis program in order to extend the specified oil change requirement in Tables 2c and 2d to this subpart. The oil analysis must be performed at the same frequency specified for changing the oil in Table 2c or 2d to this subpart. The analysis program must at a minimum analyze the following three parameters: Total Base Number, viscosity, and percent water content. The condemning limits for these parameters are as follows: Total Base Number is less than 30 percent of the Total Base Number of the oil when new; viscosity of the oil has changed by more than 20 percent from the viscosity of the oil when new; or percent water content (by volume) is greater than 0.5. If all of these condemning limits are not exceeded, the engine owner or operator is not required to change the oil. If any of the limits are exceeded, the engine owner or operator must change the oil within 2 business days of receiving the results of the analysis; if the engine is not in operation when the results of the analysis are received, the engine owner or operator must change the oil within 2 business days or before commencing operation, whichever is later. The owner or operator must keep records of the parameters that are analyzed as part of the program, the results of the analysis, and the oil changes for the engine. The analysis program must be part of the maintenance plan for the engine.

(j) If you own or operate a stationary SI engine that is subject to the work, operation or management practices in items 6, 7, or 8 of Table 2c to this subpart or in items 5, 6, 7, 9, or 11 of Table 2d to this subpart, you have the option of utilizing an oil analysis program in order to extend the specified oil change requirement in Tables 2c and 2d to this subpart. The oil analysis must be performed at the same frequency specified for changing the oil in Table 2c or 2d to this subpart. The analysis program must at a minimum analyze the following three parameters: Total Acid Number, viscosity, and percent water content. The condemning limits for these parameters are as follows: Total Acid Number increases by more than 3.0 milligrams of potassium hydroxide (KOH) per gram from Total Acid Number of the oil when new; viscosity of the oil has changed by more than 20 percent from the viscosity of the oil when new; or percent water content (by volume) is greater than 0.5. If all of these condemning limits are not exceeded, the engine owner or operator is not required to change the oil. If any of the limits are exceeded, the engine owner or operator must change the oil within 2 business days of receiving the results of the analysis; if the engine is not in operation when the results of the analysis are received, the engine owner or operator must change the oil within 2 business days or before commencing operation, whichever is later. The owner or operator must keep records of the parameters that are analyzed as part of the program, the results of the analysis, and the oil changes for the engine. The analysis program must be part of the maintenance plan for the engine.

[69 FR 33506, June 15, 2004, as amended at 73 FR 3606, Jan. 18, 2008; 75 FR 9676, Mar. 3, 2010; 75 FR 51589, Aug. 20, 2010; 76 FR 12866, Mar. 9, 2011; 78 FR 6703, Jan. 30, 2013]

§ 63.6630 How do I demonstrate initial compliance with the emission limitations, operating limitations, and other requirements?

(a) You must demonstrate initial compliance with each emission limitation, operating limitation, and other requirement that applies to you according to Table 5 of this subpart. [NA – NONE OF THE CATEGORIES IN TABLE 5 APPLY TO EMERGENCY ENGINES]

(b) [NA – PERFORMANCE TESTING NOT REQUIRED]

(c) [NA – NOCS NOT REQUIRED FOR EXISTING EMERGENCY RICE]

(d) [NA – EMERGENCY ENGINE(S)]

**SECTION E. Source Group Restrictions.**

(e) [NA – EMERGENCY ENGINE(S)]

[69 FR 33506, June 15, 2004, as amended at 78 FR 6704, Jan. 30, 2013]

Continuous Compliance Requirements

§ 63.6635 How do I monitor and collect data to demonstrate continuous compliance?

[NA – NOT SUBJECT TO EMISSION OR OPERATING LIMITATIONS]

§ 63.6640 How do I demonstrate continuous compliance with the emission limitations, operating limitations, and other requirements?

(a) You must demonstrate continuous compliance with each emission limitation, operating limitation, and other requirements in Tables 1a and 1b, Tables 2a and 2b, Table 2c, and Table 2d to this subpart that apply to you according to methods specified in Table 6 to this subpart.

TABLE 6 REQUIREMENTS

9. FOR EACH existing emergency and black start stationary RICE ≤ 500 HP located at a major source of HAP, existing non-emergency stationary RICE < 100 HP located at a major source of HAP, EXISTING EMERGENCY and black start STATIONARY RICE LOCATED AT AN AREA SOURCE OF HAP, existing non-emergency stationary CI RICE ≤ 300 HP located at an area source of HAP, existing non-emergency 2SLB stationary RICE located at an area source of HAP, existing non-emergency stationary SI RICE located at an area source of HAP which combusts landfill or digester gas equivalent to 10 percent or more of the gross heat input on an annual basis, existing non-emergency 4SLB and 4SRB stationary RICE ≤ 500 HP located at an area source of HAP, existing non-emergency 4SLB and 4SRB stationary RICE > 500 HP located at an area source of HAP that operate 24 hours or less per calendar year, and existing non-emergency 4SLB and 4SRB stationary RICE > 500 HP located at an area source of HAP that are remote stationary RICE, complying with the requirement to "Work or Management practices", you must demonstrate continuous compliance by:

i. Operating and maintaining the stationary RICE according to the manufacturer's emission-related operation and maintenance instructions; or

ii. Develop and follow your own maintenance plan which must provide to the extent practicable for the maintenance and operation of the engine in a manner consistent with good air pollution control practice for minimizing emissions.

[END OF TABLE 6 REQUIREMENTS]

(b) [NA – NOT SUBJECT TO EMISSION OR OPERATING LIMITATIONS]

(c) [NA – ANNUAL COMPLIANCE DEMONSTRATION NOT REQUIRED]

(d) [NA – NOT SUBJECT TO EMISSION OR OPERATING LIMITATIONS]

(e) You must also report each instance in which you did not meet the requirements in Table 8 to this subpart that apply to you. If you own or operate a new or reconstructed stationary RICE with a site rating of less than or equal to 500 brake HP located at a major source of HAP emissions (except new or reconstructed 4SLB engines greater than or equal to 250 and less than or equal to 500 brake HP), a new or reconstructed stationary RICE located at an area source of HAP emissions, or any of the following RICE with a site rating of more than 500 brake HP located at a major source of HAP emissions, you do not need to comply with the requirements in Table 8 to this subpart: An existing 2SLB stationary RICE, an existing 4SLB stationary RICE, an existing emergency stationary RICE, an existing limited use stationary RICE, or an existing stationary RICE which fires landfill gas or digester gas equivalent to 10 percent or more of the gross heat input on an annual basis. If you own or operate any of the following RICE with a site rating of more than 500 brake HP located at a major source of HAP emissions, you do not need to comply with the requirements in Table 8 to this subpart, except for the initial notification requirements: a new or reconstructed stationary RICE that combusts landfill gas or digester gas equivalent to 10 percent or more of the gross heat input on an annual basis, a new or reconstructed emergency stationary RICE, or a new or reconstructed limited use stationary RICE. [EXISTING EMERGENCY RICE AT AREA HAP SOURCES ARE NOT AMONG

**SECTION E. Source Group Restrictions.**

THOSE EXEMPTED FROM THIS SECTION]

(f) If you own or operate an emergency stationary RICE, you must operate the emergency stationary RICE according to the requirements in paragraphs (f)(1) through (4) of this section. In order for the engine to be considered an emergency stationary RICE under this subpart, any operation other than emergency operation, maintenance and testing, emergency demand response, and operation in non-emergency situations for 50 hours per year, as described in paragraphs (f)(1) through (4) of this section, is prohibited. If you do not operate the engine according to the requirements in paragraphs (f)(1) through (4) of this section, the engine will not be considered an emergency engine under this subpart and must meet all requirements for non-emergency engines.

(1) There is no time limit on the use of emergency stationary RICE in emergency situations.

(2) You may operate your emergency stationary RICE for any combination of the purposes specified in paragraphs (f)(2)(i) through (iii) of this section for a maximum of 100 hours per calendar year. Any operation for non-emergency situations as allowed by paragraphs (f)(3) and (4) of this section counts as part of the 100 hours per calendar year allowed by this paragraph (f)(2).

(i) Emergency stationary RICE may be operated for maintenance checks and readiness testing, provided that the tests are recommended by federal, state or local government, the manufacturer, the vendor, the regional transmission organization or equivalent balancing authority and transmission operator, or the insurance company associated with the engine. The owner or operator may petition the Administrator for approval of additional hours to be used for maintenance checks and readiness testing, but a petition is not required if the owner or operator maintains records indicating that federal, state, or local standards require maintenance and testing of emergency RICE beyond 100 hours per calendar year.

(ii)-(iii) [VACATED AS OF 5/2/16 PER COURT ORDER]

(3) [NA – NOT A MAJOR HAP SOURCE]

(4) Emergency stationary RICE located at area sources of HAP may be operated for up to 50 hours per calendar year in non-emergency situations. The 50 hours of operation in non-emergency situations are counted as part of the 100 hours per calendar year for maintenance and testing and emergency demand response provided in paragraph (f)(2) of this section. Except as provided in paragraphs (f)(4)(i) and (ii) of this section, the 50 hours per year for non-emergency situations cannot be used for peak shaving or non-emergency demand response, or to generate income for a facility to an electric grid or otherwise supply power as part of a financial arrangement with another entity.

(i) Prior to May 3, 2014, the 50 hours per year for non-emergency situations can be used for peak shaving or non-emergency demand response to generate income for a facility, or to otherwise supply power as part of a financial arrangement with another entity if the engine is operated as part of a peak shaving (load management program) with the local distribution system operator and the power is provided only to the facility itself or to support the local distribution system.

(ii) The 50 hours per year for non-emergency situations can be used to supply power as part of a financial arrangement with another entity if all of the following conditions are met:

(A) The engine is dispatched by the local balancing authority or local transmission and distribution system operator.

(B) The dispatch is intended to mitigate local transmission and/or distribution limitations so as to avert potential voltage collapse or line overloads that could lead to the interruption of power supply in a local area or region.

(C) The dispatch follows reliability, emergency operation or similar protocols that follow specific NERC, regional, state, public utility commission or local standards or guidelines.

(D) The power is provided only to the facility itself or to support the local transmission and distribution system.

(E) The owner or operator identifies and records the entity that dispatches the engine and the specific NERC, regional, state, public utility commission or local standards or guidelines that are being followed for dispatching the engine. The local balancing authority or local transmission and distribution system operator may keep these records on behalf of the engine owner or operator.

**SECTION E. Source Group Restrictions.**

[69 FR 33506, June 15, 2004, as amended at 71 FR 20467, Apr. 20, 2006; 73 FR 3606, Jan. 18, 2008; 75 FR 9676, Mar. 3, 2010; 75 FR 51591, Aug. 20, 2010; 78 FR 6704, Jan. 30, 2013]

Notifications, Reports, and Records

§ 63.6645 What notifications must I submit and when?

(a) You must submit all of the notifications in §§ 63.7(b) and (c), 63.8(e), (f)(4) and (f)(6), 63.9(b) through (e), and (g) and (h) that apply to you by the dates specified if you own or operate any of the following;

(1) [NA – NOT A MAJOR HAP SOURCE]

(2) [NA PER (5) BELOW]

(3) [NA – NOT A MAJOR HAP SOURCE]

(4) [NA – NOT A MAJOR HAP SOURCE]

(5) THIS REQUIREMENT DOES NOT APPLY IF YOU OWN OR OPERATE an existing stationary RICE less than 100 HP, AN EXISTING STATIONARY EMERGENCY RICE, OR AN EXISTING STATIONARY RICE THAT IS NOT SUBJECT TO ANY NUMERICAL EMISSION STANDARDS.

(b) [NA – NOT A MAJOR HAP SOURCE]

(c) [NA – NOT A MAJOR HAP SOURCE]

(d) [NA – NOT A MAJOR HAP SOURCE]

(e) [NA – NOT A MAJOR HAP SOURCE]

(f) [NA – 63.6590(b) DOES NOT APPLY]

(g) [NA – PERFORMANCE TEST NOT REQUIRED]

(h) [NA – PERFORMANCE TEST NOT REQUIRED]

(i) [NA – EMERGENCY ENGINE(S)]

[73 FR 3606, Jan. 18, 2008, as amended at 75 FR 9677, Mar. 3, 2010; 75 FR 51591, Aug. 20, 2010; 78 FR 6705preview citation details, Jan. 30, 2013; 85 FR 73912, Nov. 19, 2020]

§ 63.6650 What reports must I submit and when?

(a) You must submit each report in Table 7 of this subpart that applies to you.

TABLE 7 REQUIREMENTS

4. For each emergency stationary RICE that operate or are contractually obligated to be available for more than 15 hours per year for the purposes specified in § 63.6640(f)(2)(ii) and (iii) or that operate for the purposes specified in § 63.6640(f)(4)(ii), you must submit a Report. The report must contain the information in § 63.6650(h)(1). You must submit the report annually according to the requirements in § 63.6650(h)(2)-(3).

[END OF TABLE 7 REQUIREMENTS]

(b) Unless the Administrator has approved a different schedule for submission of reports under § 63.10(a), you must submit each report by the date in Table 7 of this subpart and according to the requirements in paragraphs (b)(1) through (b)(9) of this section.

**SECTION E. Source Group Restrictions.**

- (1) [NA – ANNUAL REPORT REQUIRED, ONLY UNDER CERTAIN CONDITIONS]
- (2) [NA – ANNUAL REPORT REQUIRED, ONLY UNDER CERTAIN CONDITIONS]
- (3) [NA – ANNUAL REPORT REQUIRED, ONLY UNDER CERTAIN CONDITIONS]
- (4) [NA – ANNUAL REPORT REQUIRED, ONLY UNDER CERTAIN CONDITIONS]
- (5) [NA – ANNUAL REPORT REQUIRED, ONLY UNDER CERTAIN CONDITIONS]
- (6) For annual Compliance reports, the first Compliance report must cover the period beginning on the compliance date that is specified for your affected source in § 63.6595 and ending on December 31.
- (7) For annual Compliance reports, the first Compliance report must be postmarked or delivered no later than January 31 following the end of the first calendar year after the compliance date that is specified for your affected source in § 63.6595.
- (8) For annual Compliance reports, each subsequent Compliance report must cover the annual reporting period from January 1 through December 31.
- (9) For annual Compliance reports, each subsequent Compliance report must be postmarked or delivered no later than January 31.
- (c) [NA – “COMPLIANCE REPORT” NOT REQUIRED]
- (d) [NA – NOT SUBJECT TO EMISSION OR OPERATING LIMITATIONS]
- (e) [NA – NOT SUBJECT TO EMISSION OR OPERATING LIMITATIONS]
- (f) [NA – NOT SUBJECT TO TITLE V PERMITTING]
- (g) [NA – LFG NOT USED]
- (h) If you own or operate an emergency stationary RICE with a site rating of more than 100 brake HP that operates or is contractually obligated to be available for more than 15 hours per calendar year for the purposes specified in § 63.6640(f)(2)(ii) and (iii) or that operates for the purpose specified in § 63.6640(f)(4)(ii), you must submit an annual report according to the requirements in paragraphs (h)(1) through (3) of this section.
 - (1) The report must contain the following information:
 - (i) Company name and address where the engine is located.
 - (ii) Date of the report and beginning and ending dates of the reporting period.
 - (iii) Engine site rating and model year.
 - (iv) Latitude and longitude of the engine in decimal degrees reported to the fifth decimal place.
 - (v) Hours operated for the purposes specified in § 63.6640(f)(2)(ii) and (iii), including the date, start time, and end time for engine operation for the purposes specified in § 63.6640(f)(2)(ii) and (iii).
 - (vi) Number of hours the engine is contractually obligated to be available for the purposes specified in § 63.6640(f)(2)(ii) and (iii).
 - (vii) Hours spent for operation for the purpose specified in § 63.6640(f)(4)(ii), including the date, start time, and end time for engine operation for the purposes specified in § 63.6640(f)(4)(ii). The report must also identify the entity that dispatched the engine and the situation that necessitated the dispatch of the engine.

**SECTION E. Source Group Restrictions.**

(viii) If there were no deviations from the fuel requirements in § 63.6604 that apply to the engine (if any), a statement that there were no deviations from the fuel requirements during the reporting period.

(ix) If there were deviations from the fuel requirements in § 63.6604 that apply to the engine (if any), information on the number, duration, and cause of deviations, and the corrective action taken.

(2) The first annual report must cover the calendar year 2015 and must be submitted no later than March 31, 2016. Subsequent annual reports for each calendar year must be submitted no later than March 31 of the following calendar year.

(3) The annual report must be submitted electronically using the subpart specific reporting form in the Compliance and Emissions Data Reporting Interface (CEDRI) that is accessed through EPA's Central Data Exchange (CDX) (www.epa.gov/cdx). However, if the reporting form specific to this subpart is not available in CEDRI at the time that the report is due, the written report must be submitted to the Administrator at the appropriate address listed in § 63.13.

[69 FR 33506, June 15, 2004, as amended at 75 FR 9677, Mar. 3, 2010; 78 FR 6705, Jan. 30, 2013]

§ 63.6655 What records must I keep?

(a) [NA – NOT SUBJECT TO EMISSION OR OPERATING LIMITATIONS]

(b) [NA – NO CEMS OR CPMS]

(c) [NA – LFG NOT USED]

(d) [NA – NOT SUBJECT TO EMISSION OR OPERATING LIMITATIONS]

(e) You must keep records of the maintenance conducted on the stationary RICE in order to demonstrate that you operated and maintained the stationary RICE and after-treatment control device (if any) according to your own maintenance plan if you own or operate any of the following stationary RICE;

(1) [NA – NOT A MAJOR HAP SOURCE]

(2) An existing stationary emergency RICE.

(3) An existing stationary RICE located at an area source of HAP emissions subject to management practices as shown in Table 2d to this subpart.

(f) If you own or operate any of the stationary RICE in paragraphs (f)(1) through (2) of this section, you must keep records of the hours of operation of the engine that is recorded through the non-resettable hour meter. The owner or operator must document how many hours are spent for emergency operation, including what classified the operation as emergency and how many hours are spent for non-emergency operation. If the engine is used for the purposes specified in § 63.6640(f)(2)(ii) or (iii) or § 63.6640(f)(4)(ii), the owner or operator must keep records of the notification of the emergency situation, and the date, start time, and end time of engine operation for these purposes.

(1) [NA – NOT A MAJOR HAP SOURCE]

(2) An existing emergency stationary RICE located at an area source of HAP emissions that does not meet the standards applicable to non-emergency engines.

[69 FR 33506, June 15, 2004, as amended at 75 FR 9678, Mar. 3, 2010; 75 FR 51592, Aug. 20, 2010; 78 FR 6706, Jan. 30, 2013]

§ 63.6660 In what form and how long must I keep my records?

(a) Your records must be in a form suitable and readily available for expeditious review according to § 63.10(b)(1).

(b) As specified in § 63.10(b)(1), you must keep each record for 5 years following the date of each occurrence,

**SECTION E. Source Group Restrictions.**

measurement, maintenance, corrective action, report, or record.

(c) You must keep each record readily accessible in hard copy or electronic form for at least 5 years after the date of each occurrence, measurement, maintenance, corrective action, report, or record, according to § 63.10(b)(1).

[69 FR 33506, June 15, 2004, as amended at 75 FR 9678, Mar. 3, 2010]

Other Requirements and Information

§ 63.6665 What parts of the General Provisions apply to me?

Table 8 to this subpart shows which parts of the General Provisions in §§ 63.1 through 63.15 apply to you. If you own or operate a new or reconstructed stationary RICE with a site rating of less than or equal to 500 brake HP located at a major source of HAP emissions (except new or reconstructed 4SLB engines greater than or equal to 250 and less than or equal to 500 brake HP), a new or reconstructed stationary RICE located at an area source of HAP emissions, or any of the following RICE with a site rating of more than 500 brake HP located at a major source of HAP emissions, you do not need to comply with any of the requirements of the General Provisions specified in Table 8: An existing 2SLB stationary RICE, an existing 4SLB stationary RICE, an existing stationary RICE that combusts landfill or digester gas equivalent to 10 percent or more of the gross heat input on an annual basis, an existing emergency stationary RICE, or an existing limited use stationary RICE. If you own or operate any of the following RICE with a site rating of more than 500 brake HP located at a major source of HAP emissions, you do not need to comply with the requirements in the General Provisions specified in Table 8 except for the initial notification requirements: A new stationary RICE that combusts landfill gas or digester gas equivalent to 10 percent or more of the gross heat input on an annual basis, a new emergency stationary RICE, or a new limited use stationary RICE. [EXISTING EMERGENCY RICE AT AREA HAP SOURCES ARE NOT AMONG THOSE EXEMPTED FROM THIS SECTION]

[75 FR 9678, Mar. 3, 2010]

Reporting Addresses & Regulatory Changes:

Individual sources within this source group that are subject to 40 CFR Part 63 Subpart ZZZZ -National Emissions Standards for Hazardous Air Pollutants for Stationary Reciprocating Internal Combustion Engines shall comply with all applicable requirements of the Subpart. 40 CFR 63.13(a) requires submission of copies of all requests, reports and other communications to both the DEP and the EPA. The EPA copies shall be forwarded to:

Associate Director
Office of Enforcement and Compliance Assistance, 3AP20
U.S. EPA Region III
1650 Arch Street
Philadelphia, PA 19103-2029

The DEP copies shall be forwarded to the DEP SCRO Air Quality Program Manager at wiveaver@pa.gov, unless otherwise directed in writing by DEP.

In the event that the Federal Subpart that is the subject of this Source Group is revised, the permittee shall comply with the revised version of the subpart, and shall not be required to comply with any provisions in this permit designated as having the subpart as their authority, to the extent that such permit provisions would be inconsistent with the applicable provisions of the revised subpart.

***** Permit Shield in Effect. *****

**SECTION E. Source Group Restrictions.**

Group Name: GROUP 006

Group Description: 40 CFR Part 60, Subpart Dc Requirements

Sources included in this group

ID	Name
032	NEBRASKA BOILER

I. RESTRICTIONS.**Emission Restriction(s).****# 001 [40 CFR Part 60 Standards of Performance for New Stationary Sources §40 CFR 60.40c]****Subpart Dc - Standards of Performance for Small Industrial- Commercial-Institutional Steam Generating Units
Applicability and delegation of authority.**

§ 60.40c Applicability and delegation of authority.

(a) Except as provided in paragraphs (d), (e), (f), and (g) of this section, the affected facility to which this subpart applies is each steam generating unit for which construction, modification, or reconstruction is commenced after June 9, 1989 and that has a maximum design heat input capacity of 29 megawatts (MW) (100 million British thermal units per hour (MMBtu/h)) or less, but greater than or equal to 2.9 MW (10 MMBtu/h).

(b) In delegating implementation and enforcement authority to a State under section 111(c) of the Clean Air Act, § 60.48c(a)(4) shall be retained by the Administrator and not transferred to a State.

(c) [NA – UNIT(S) NOT ASSOCIATED WITH COMBUSTION RESEARCH]

(d) [NA – UNIT(S) NOT ASSOCIATED WITH COMBUSTION RESEARCH]

(e) [NA – UNIT(S) NOT ASSOCIATED WITH STATIONARY COMBUSTION TURBINE]

(f) [NA – NOT SUBJECT TO NSPS AAAA OR CCCC]

(g) [NA – NOT SUBJECT TO NSPS BBBB]

(h) [NA – NOT SUBJECT TO NSPS J OR Ja]

(i) [NA – UNIT(S) ARE NOT TEMPORARY BOILERS]

[72 FR 32759, June 13, 2007, as amended at 74 FR 5090, Jan. 28, 2009; 77 FR 9461, Feb. 16, 2012]

§ 60.42c Standard for sulfur dioxide (SO₂).

(a) [NA – UNIT(S) NOT COAL FIRED]

(b) [NA – UNIT(S) NOT COAL FIRED]

(c) [NA – UNIT(S) NOT COAL FIRED]

(d) On and after the date on which the initial performance test is completed or required to be completed under § 60.8, whichever date comes first, no owner or operator of an affected facility that combusts oil shall cause to be discharged into the atmosphere from that affected facility any gases that contain SO₂ in excess of 215 ng/J (0.50 lb/MMBtu) heat input from oil; or, as an alternative, no owner or operator of an affected facility that combusts oil shall combust oil in the affected facility that contains greater than 0.5 weight percent sulfur. The percent reduction requirements are not applicable to affected facilities under this paragraph.

(e) [NA – MULTIPLE SIMULTANEOUS FUELS NOT USED]

(f) [NA – UNIT(S) NOT COAL FIRED]

**SECTION E. Source Group Restrictions.**

(g) [NA - PARAGRAPH (h) APPLIES]

(h) For affected facilities listed under paragraphs (h)(1), (2), (3), or (4) of this section, compliance with the emission limits or fuel oil sulfur limits under this section may be determined based on a certification from the fuel supplier, as described under § 60.48c(f), as applicable.

(1) Distillate oil-fired affected facilities with heat input capacities between 2.9 and 29 MW (10 and 100 MMBtu/hr).

(2) [NA – UNIT(S) NOT RESIDUAL OIL FIRED]

(3) [NA – UNIT(S) NOT COAL FIRED]

(4) Other fuels-fired affected facilities with heat input capacities between 2.9 and 8.7 MW (10 and 30 MMBtu/h).

(i) The SO₂ emission limits, fuel oil sulfur limits, and percent reduction requirements under this section apply at all times, including periods of startup, shutdown, and malfunction.

(j) [NA – UNIT(S) NOT IN NON-CONTINENTAL AREA]

[72 FR 32759, June 13, 2007, as amended at 74 FR 5090, Jan. 28, 2009; 77 FR 9462, Feb. 16, 2012]

§ 60.43c Standard for particulate matter (PM).

(a) [NA – UNIT(S) NOT COAL FIRED]

(b) [NA – UNIT(S) NOT WOOD FIRED]

(c) On and after the date on which the initial performance test is completed or required to be completed under § 60.8, whichever date comes first, no owner or operator of an affected facility that combusts coal, wood, or oil and has a heat input capacity of 8.7 MW (30 MMBtu/h) or greater shall cause to be discharged into the atmosphere from that affected facility any gases that exhibit greater than 20 percent opacity (6-minute average), except for one 6-minute period per hour of not more than 27 percent opacity. Owners and operators of an affected facility that elect to install, calibrate, maintain, and operate a continuous emissions monitoring system (CEMS) for measuring PM emissions according to the requirements of this subpart and are subject to a federally enforceable PM limit of 0.030 lb/MMBtu or less are exempt from the opacity standard specified in this paragraph (c).

(d) The PM and opacity standards under this section apply at all times, except during periods of startup, shutdown, or malfunction.

(e) [NA - UNIT WAS INSTALLED IN BEFORE 2/28/05]

[72 FR 32759, June 13, 2007, as amended at 74 FR 5091, Jan. 28, 2009; 77 FR 9462, Feb. 16, 2012]

§ 60.44c Compliance and performance test methods and procedures for sulfur dioxide.

(a) – (g) [NA - PARAGRAPH (h) APPLIES]

(h) For affected facilities subject to § 60.42c(h)(1), (2), or (3) where the owner or operator seeks to demonstrate compliance with the SO₂ standards based on fuel supplier certification, the performance test shall consist of the certification from the fuel supplier, as described in § 60.48c(f), as applicable.

(i) [NA – UNIT(S) NOT COAL FIRED]

(j) [NA - PARAGRAPH (h) APPLIES]

[72 FR 32759, June 13, 2007, as amended at 74 FR 5091, Jan. 28, 2009]

**SECTION E. Source Group Restrictions.**

§ 60.45c Compliance and performance test methods and procedures for particulate matter.

(a) [INITIAL PERFORMANCE TESTING REQUIREMENT IS IN THE PAST]

(b) [NA - NOT SUBJECT TO § 60.43c(b)(2)]

(c) [NA- CEMS NOT USED]

(d) [NA - NOT SUBJECT TO § 60.43c(e)]

[72 FR 32759, June 13, 2007, as amended at 74 FR 5091, Jan. 28, 2009; 76 FR 3523, Jan. 20, 2011; 77 FR 9463, Feb. 16, 2012]

§ 60.46c Emission monitoring for sulfur dioxide.

(a) – (d) [NA - PARAGRAPH (e) APPLIES]

(e) The monitoring requirements of paragraphs (a) and (d) of this section shall not apply to affected facilities subject to § 60.42c(h) (1), (2), or (3) where the owner or operator of the affected facility seeks to demonstrate compliance with the SO₂ standards based on fuel supplier certification, as described under § 60.48c(f), as applicable.

(f) [NA - PARAGRAPH (e) APPLIES]

§ 60.47c Emission monitoring for particulate matter.

(a) [FIRST SENTENCE OF THIS SUBSECTION IS NA, AND HAS BEEN OMITTED BECAUSE (f) APPLIES] The owner or operator of an affected facility subject to an opacity standard in § 60.43c(c) that is not required to use a COMS due to paragraphs (c), (d), (e), or (f) of this section that elects not to use a COMS shall conduct a performance test using Method 9 of appendix A-4 of this part and the procedures in § 60.11 to demonstrate compliance with the applicable limit in § 60.43c by April 29, 2011, within 45 days of stopping use of an existing COMS, or within 180 days after initial startup of the facility, whichever is later, and shall comply with either paragraphs (a)(1), (a)(2), or (a)(3) of this section. The observation period for Method 9 of appendix A-4 of this part performance tests may be reduced from 3 hours to 60 minutes if all 6-minute averages are less than 10 percent and all individual 15-second observations are less than or equal to 20 percent during the initial 60 minutes of observation.

(1) Except as provided in paragraph (a)(2) and (a)(3) of this section, the owner or operator shall conduct subsequent Method 9 of appendix A-4 of this part performance tests using the procedures in paragraph (a) of this section according to the applicable schedule in paragraphs (a)(1)(i) through (a)(1)(iv) of this section, as determined by the most recent Method 9 of appendix A-4 of this part performance test results.

(i) If no visible emissions are observed, a subsequent Method 9 of appendix A-4 of this part performance test must be completed within 12 calendar months from the date that the most recent performance test was conducted or within 45 days of the next day that fuel with an opacity standard is combusted, whichever is later;

(ii) If visible emissions are observed but the maximum 6-minute average opacity is less than or equal to 5 percent, a subsequent Method 9 of appendix A-4 of this part performance test must be completed within 6 calendar months from the date that the most recent performance test was conducted or within 45 days of the next day that fuel with an opacity standard is combusted, whichever is later;

(iii) If the maximum 6-minute average opacity is greater than 5 percent but less than or equal to 10 percent, a subsequent Method 9 of appendix A-4 of this part performance test must be completed within 3 calendar months from the date that the most recent performance test was conducted or within 45 days of the next day that fuel with an opacity standard is combusted, whichever is later; or

(iv) If the maximum 6-minute average opacity is greater than 10 percent, a subsequent Method 9 of appendix A-4 of this part performance test must be completed within 45 calendar days from the date that the most recent performance test was conducted.

**SECTION E. Source Group Restrictions.**

(2) If the maximum 6-minute opacity is less than 10 percent during the most recent Method 9 of appendix A-4 of this part performance test, the owner or operator may, as an alternative to performing subsequent Method 9 of appendix A-4 of this part performance tests, elect to perform subsequent monitoring using Method 22 of appendix A-7 of this part according to the procedures specified in paragraphs (a)(2)(i) and (ii) of this section.

(i) The owner or operator shall conduct 10 minute observations (during normal operation) each operating day the affected facility fires fuel for which an opacity standard is applicable using Method 22 of appendix A-7 of this part and demonstrate that the sum of the occurrences of any visible emissions is not in excess of 5 percent of the observation period (i.e. , 30 seconds per 10 minute period). If the sum of the occurrence of any visible emissions is greater than 30 seconds during the initial 10 minute observation, immediately conduct a 30 minute observation. If the sum of the occurrence of visible emissions is greater than 5 percent of the observation period (i.e., 90 seconds per 30 minute period), the owner or operator shall either document and adjust the operation of the facility and demonstrate within 24 hours that the sum of the occurrence of visible emissions is equal to or less than 5 percent during a 30 minute observation (i.e., 90 seconds) or conduct a new Method 9 of appendix A-4 of this part performance test using the procedures in paragraph (a) of this section within 45 calendar days according to the requirements in § 60.45c(a)(8).

(ii) If no visible emissions are observed for 10 operating days during which an opacity standard is applicable, observations can be reduced to once every 7 operating days during which an opacity standard is applicable. If any visible emissions are observed, daily observations shall be resumed.

(3) [NA - DIGITAL OPACITY COMPLIANCE SYSTEM NOT USED]

(b) [NA – COMS NOT REQUIRED OR USED]

(c) Owners and operators of an affected facilities that burn only distillate oil that contains no more than 0.5 weight percent sulfur and/or liquid or gaseous fuels with potential sulfur dioxide emission rates of 26 ng/J (0.060 lb/MMBtu) heat input or less and that do not use a post-combustion technology to reduce SO₂ or PM emissions and that are subject to an opacity standard in § 60.43c(c) are not required to operate a COMS if they follow the applicable procedures in § 60.48c(f).

(d) [NA - PM CEMS NOT USED]

(e) [NA - DOES NOT MAINTAIN CO EMISSION RECORDS ON AN OPERATING DAY BASIS]

(f) An owner or operator of an affected facility that is subject to an opacity standard in § 60.43c(c) is not required to operate a COMS provided that the affected facility meets the conditions in either paragraphs (f)(1), (2), or (3) of this section.

(1) [NA - NO BAGHOUSE]

(2) [NA - NO ESP]

(3) [NA – 60.47c(c) APPLIES]

[72 FR 32759, June 13, 2007, as amended at 74 FR 5091, Jan. 28, 2009; 76 FR 3523, Jan. 20, 2011; 77 FR 9463, Feb. 16, 2012]

§ 60.48c Reporting and recordkeeping requirements.

(a) [NA – STARTUP IS IN THE PAST]

(b) The owner or operator of each affected facility subject to the SO₂ emission limits of § 60.42c, or the PM or opacity limits of § 60.43c, shall submit to the Administrator the performance test data from the initial and any subsequent performance tests and, if applicable, the performance evaluation of the CEMS and/or COMS using the applicable performance specifications in appendix B of this part.

(c) In addition to the applicable requirements in § 60.7, the owner or operator of an affected facility subject to the opacity limits in § 60.43c(c) shall submit excess emission reports for any excess emissions from the affected facility that occur during the reporting period and maintain records according to the requirements specified in paragraphs (c)(1) through (3) of

**SECTION E. Source Group Restrictions.**

this section, as applicable to the visible emissions monitoring method used.

(1) For each performance test conducted using Method 9 of appendix A-4 of this part, the owner or operator shall keep the records including the information specified in paragraphs (c)(1)(i) through (iii) of this section.

(i) Dates and time intervals of all opacity observation periods;

(ii) Name, affiliation, and copy of current visible emission reading certification for each visible emission observer participating in the performance test; and

(iii) Copies of all visible emission observer opacity field data sheets;

(2) For each performance test conducted using Method 22 of appendix A-4 of this part, the owner or operator shall keep the records including the information specified in paragraphs (c)(2)(i) through (iv) of this section.

(i) Dates and time intervals of all visible emissions observation periods;

(ii) Name and affiliation for each visible emission observer participating in the performance test;

(iii) Copies of all visible emission observer opacity field data sheets; and

(iv) Documentation of any adjustments made and the time the adjustments were completed to the affected facility operation by the owner or operator to demonstrate compliance with the applicable monitoring requirements.

(3) For each digital opacity compliance system, the owner or operator shall maintain records and submit reports according to the requirements specified in the site-specific monitoring plan approved by the Administrator

(d) The owner or operator of each affected facility subject to the SO₂ emission limits, fuel oil sulfur limits, or percent reduction requirements under § 60.42c shall submit reports to the Administrator.

(e) The owner or operator of each affected facility subject to the SO₂ emission limits, fuel oil sulfur limits, or percent reduction requirements under § 60.42c shall keep records and submit reports as required under paragraph (d) of this section, including the following information, as applicable.

(1) Calendar dates covered in the reporting period.

(2) – (10) [NA – FUEL SUPPLIER CERTIFICATION USED]

(11) If fuel supplier certification is used to demonstrate compliance, records of fuel supplier certification as described under paragraph (f)(1), (2), (3), or (4) of this section, as applicable. In addition to records of fuel supplier certifications, the report shall include a certified statement signed by the owner or operator of the affected facility that the records of fuel supplier certifications submitted represent all of the fuel combusted during the reporting period.

(f) Fuel supplier certification shall include the following information:

(1) For distillate oil:

(i) The name of the oil supplier;

(ii) A statement from the oil supplier that the oil complies with the specifications under the definition of distillate oil in § 60.41c; and

(iii) The sulfur content or maximum sulfur content of the oil.

(2) [NA – UNIT(S) NOT RESIDUAL OIL FIRED]

(3) [NA – UNIT(S) NOT COAL FIRED]

**SECTION E. Source Group Restrictions.**

(4) For other fuels:

(i) The name of the supplier of the fuel;

(ii) The potential sulfur emissions rate or maximum potential sulfur emissions rate of the fuel in ng/J heat input; and

(iii) The method used to determine the potential sulfur emissions rate of the fuel.

(g)(1) Except as provided under paragraphs (g)(2) and (g)(3) of this section, the owner or operator of each affected facility shall record and maintain records of the amount of each fuel combusted during each operating day.

(2) As an alternative to meeting the requirements of paragraph (g)(1) of this section, the owner or operator of an affected facility that combusts only natural gas, wood, fuels using fuel certification in § 60.48c(f) to demonstrate compliance with the SO₂ standard, fuels not subject to an emissions standard (excluding opacity), or a mixture of these fuels may elect to record and maintain records of the amount of each fuel COMBUSTED during each calendar month.

(3) As an alternative to meeting the requirements of paragraph (g)(1) of this section, the owner or operator of an affected facility or multiple affected facilities located on a contiguous property unit where the only fuels combusted in any steam generating unit (including steam generating units not subject to this subpart) at that property are natural gas, wood, distillate oil meeting the most current requirements in § 60.42C to use fuel certification to demonstrate compliance with the SO₂ standard, and/or fuels, excluding coal and residual oil, not subject to an emissions standard (excluding opacity) may elect to record and maintain records of the total amount of each steam generating unit fuel DELIVERED to that property during each calendar month.

(h) [NA – UNIT(S) NO ANNUAL CAPACITY FACTOR]

(j) The reporting period for the reports required under this subpart is each six-month period. All reports shall be submitted to the Administrator and shall be postmarked by the 30th day following the end of the reporting period. [SIX MONTHS PERIODS SHALL BE DEFINED AS CALENDAR HALVES]

[72 FR 32759, June 13, 2007, as amended at 74 FR 5091, Jan. 28, 2009]

Reporting Requirements & Regulatory Changes

Individual sources within this source group that are subject to 40 CFR Part 60 Subpart Dc shall comply with all applicable requirements of the Subpart. 40 CFR 60.8 requires submission of copies of all requests, reports and other communications to both the Department and the EPA. The EPA copies shall be forwarded to:

Associate Director
Office of Enforcement and Compliance Assistance, 3AP20
U.S. EPA Region III
1650 Arch Street
Philadelphia, PA 19103-2029

The DEP copies shall be forwarded to the DEP SCRO Air Quality Program Manager at wiweaver@pa.gov, unless otherwise directed in writing by DEP.

In the event that the Federal Subpart that is the subject of this Source Group is revised, the permittee shall comply with the revised version of the subpart, and shall not be required to comply with any provisions in this permit designated as having the subpart as their authority, to the extent that such permit provisions would be inconsistent with the applicable provisions of the revised subpart.



SECTION E. Source Group Restrictions.

II. TESTING REQUIREMENTS.

No additional testing requirements exist except as provided in other sections of this permit including Section B (Title V General Requirements).

III. MONITORING REQUIREMENTS.

No additional monitoring requirements exist except as provided in other sections of this permit including Section B (Title V General Requirements).

IV. RECORDKEEPING REQUIREMENTS.

No additional record keeping requirements exist except as provided in other sections of this permit including Section B (Title V General Requirements).

V. REPORTING REQUIREMENTS.

No additional reporting requirements exist except as provided in other sections of this permit including Section B (Title V General Requirements).

VI. WORK PRACTICE REQUIREMENTS.

No additional work practice requirements exist except as provided in other sections of this permit including Section B (Title V General Requirements).

VII. ADDITIONAL REQUIREMENTS.

No additional requirements exist except as provided in other sections of this permit including Section B (Title V General Requirements).

***** Permit Shield in Effect. *****

**SECTION E. Source Group Restrictions.**

Group Name: GROUP 007

Group Description: 40 CFR Part 64, CAM Requirements Cyclones\Baghouses

Sources included in this group

ID	Name
230	MILK CRUMB PROCESSING SYSTEM
401	JETZONE #1 BEAN CLEANER/SEPARATOR
402	JETZONE #1 BEAN ROASTER AND COOLER
403	JETZONE #1 WINNOWING OPERATIONS
501	JETZONE #2 COCOA BEAN CLEANING
503	JETZONE #2 WINNOWER OPERATIONS
601	WINNOWER
603	BEAN TRANSPORTER

I. RESTRICTIONS.

No additional requirements exist except as provided in other sections of this permit including Section B (Title V General Requirements).

II. TESTING REQUIREMENTS.

No additional testing requirements exist except as provided in other sections of this permit including Section B (Title V General Requirements).

III. MONITORING REQUIREMENTS.**# 001 [40 CFR Part 64 Compliance Assurance Monitoring for Major Stationary Sources §40 CFR 64.3]****Sections of PART 64****Monitoring design criteria**

(a) The permittee shall operate and maintain a manometer to measure the pressure differential across each of the following fabric filters and/or cyclones associated with the above sources.

C230A Fabric Filter
 C230B Fabric Filter
 C230C Fabric Filter
 C230D Fabric Filter
 C230G Fabric Filter
 C401 Fabric Filter
 C402A Cyclone
 C402B Cyclone
 C402C Cyclone
 C402D Cyclone
 C403A Fabric Filter
 C403B Fabric Filter
 C501A Fabric Filter
 C501B Fabric Filter
 C503A Fabric Filter
 C503B Fabric Filter
 C601 Fabric Filter
 C603 Fabric Filter

(b) The permittee shall use the pressure differential across each of the fabric filters and/or cyclones to obtain data and monitor the emission control equipment performance.

(c) The permittee shall obtain the pressure differential across each of the fabric filters and/or cyclones once per day while the source and respective control device(s) are operating.

**SECTION E. Source Group Restrictions.****IV. RECORDKEEPING REQUIREMENTS.****# 002 [40 CFR Part 64 Compliance Assurance Monitoring for Major Stationary Sources §40 CFR 64.9]****Sections of PART 64****Reporting and recordkeeping requirements**

(a) The permittee shall maintain records of the following information:

(1) Daily readings of the pressure differential across the fabric filters and/or cyclones.

(2) The permittee shall record all excursions and corrective actions taken in response to an excursion and the time elapsed until the corrective actions have been taken.

(3) The permittee shall record all inspections, repairs and maintenance performed on the monitoring equipment, fabric filters, and/or cyclones.

(4) The permittee shall maintain records of all monitoring equipment down time incidents (other than down time associated with accuracy checks or calibration checks). The permittee shall also record the dates, times and durations, possible causes and corrective actions taken for the incidents.

(b) The permittee shall keep all records for a period of five (5) years and make the records available to the Department upon request.

V. REPORTING REQUIREMENTS.**# 003 [40 CFR Part 64 Compliance Assurance Monitoring for Major Stationary Sources §40 CFR 64.9]****Sections of PART 64****Reporting and recordkeeping requirements**

(a) The permittee shall report all excursions and corrective actions taken, the dates, times, durations and possible causes, every six (6) months.

(b) The permittee shall report all monitoring equipment down time incidents (other than down time associated with accuracy checks or calibration checks), their dates, times and durations, possible causes and corrective actions taken, every six (6) months.

VI. WORK PRACTICE REQUIREMENTS.**# 004 [40 CFR Part 64 Compliance Assurance Monitoring for Major Stationary Sources §40 CFR 64.6]****Sections of PART 64****Approval of monitoring**

(a) A range of 0.5 to 10.0 inches of water column shall be used in determining the proper operation of the fabric filters and/or cyclones listed in Condition #001.

(b) The prescribed ranges shall be used to determine proper fabric filter and/or cyclone operation at all times when the above source(s) are in operation except during the following:

(1) The initial break-in period for new collector bags.

(2) The first 15 minutes during the initial start-up of the source.

(c) A departure from the pressure differential ranges specified in (a), above shall be defined as an excursion. Failure to perform a daily pressure differential monitoring shall also be defined as an excursion.

(d) The permittee shall operate and maintain a pressure monitoring device to measure the pressure differential across each of the fabric filters and/or cyclones. The monitoring device shall measure the pressure differential of the inlet and outlet of the respective control device.

(e) The permittee shall check the pressure monitoring devices a minimum of once per year to ensure measurement accuracy to within 10%. A monitoring device that is not operating with a measurement accuracy to within 10% shall be repaired or replaced. Results of the annual measurement accuracy checks shall be retained on site for a minimum of five (5) years and be made available to the Department upon request.

**SECTION E. Source Group Restrictions.**

(f) Fabric Filters - The permittee shall annually shutdown the unit to open and inspect bags for tears, clean air chamber for dust, shaft bearings on exhauster fan, and motor for wear and lubrication, repair/replace if necessary. Also, with system operating, inspect access doors for air leakage, replace worn gasketing if required, and inspect exhauster fan for balance, repair or replace as necessary.

(g) Cyclones - The permittee shall annually shutdown the unit to open and inspect the interior of the cyclone and ductwork for wear, and repair if necessary; inspect the doors and ductwork for leakage, and replace worn gasketing if necessary.

VII. ADDITIONAL REQUIREMENTS.**# 005 [40 CFR Part 64 Compliance Assurance Monitoring for Major Stationary Sources §40 CFR 64.8]****Sections of PART 64****Quality improvement plan (QIP) requirements**

(a) The permittee shall develop and implement a quality improvement plan (QIP) as expeditiously as practicable if any of the following occurs:

(1) Six excursions for any individual parameter that occurs in a six-month reporting period.

(2) The Department determines after review of all reported information that the permittee has not responded acceptably to an excursion.

(b) The QIP should be developed within 60 days and the permittee shall provide a copy of the QIP to the Department. Furthermore, the permittee shall notify the Department if the period for completing the improvements contained in the QIP exceeds 180 days from the date on which the need to implement the QIP was determined.

(c) The permittee shall record actions taken to implement the QIP during a reporting period and all related actions including, but not limited to inspections, repairs and maintenance performed on the monitoring equipment.

(d) The QIP shall include procedures for evaluating the control performance problems. Based on the results of the evaluation procedures, the permittee shall modify the QIP, and provide a copy to the Department, to include procedures for conducting more frequent or improved monitoring in conjunction with one or more of the following:

- (1) Improved preventive maintenance practices.
- (2) Process operation changes.
- (3) Appropriate improvements to control methods.
- (4) Other steps appropriate to correct performance.

(e) Following implementation of a QIP, the Department will require reasonable revisions to the QIP if the plan has failed to either:

(1) Address the cause of the control device performance problem.

(2) Provide adequate procedures for correcting control device performance problems in as expeditiously as practicable in accordance with good air pollution control practices for minimizing emissions.

(f) Implementation of a QIP shall not excuse the owner or operator of a source from compliance with any existing emission limitation or standard or any existing monitoring, testing, reporting or recordkeeping requirement that may apply under any federal, state, or local laws or any other applicable requirements under the Clean Air Act.

***** Permit Shield in Effect. *****



SECTION F. Alternative Operation Requirements.

No Alternative Operations exist for this Title V facility.



SECTION G. Emission Restriction Summary.

No emission restrictions listed in this section of the permit.

**SECTION H. Miscellaneous.**

This operating permit renewal supersedes operating permit No. 36-05142 that was issued on April 26, 2017, and amended on March 16, 2018.

001: The following sources do not require any restrictions, work practice standards or testing, monitoring, recordkeeping and reporting requirements:

- NG-Fired R&D Dryer
- Natural Gas-Fired Space Heater (75,000 Btu/hr)
- Natural Gas-Fired Space Heater (130,000 Btu/hr)
- R&D Pre-Grind Mill
- Crumb Pilot Plant Dust Collector
- (3) Cooling Towers
- No. 2 Fuel Oil Storage Tank (25,000 gallons)
- Food Flavorings - Various Alcohol Based
- Denatured Alcohol
- Isopropyl Alcohol - 70%
- Fugitive
- Bulk Bean Unloading System - Internal Discharge
- Fine/Shell Loading
- Cocoa Bean Area Receiving Baghouse Exhaust # 2 (N0 11) - Internal Discharge
- Cocoa Bean Receiving, Cleaning & Conveying Baghouse # I Exhaust - Internal Discharge
- Dark Chocolate Sugar Conveying Baghouse Exhaust - Internal Discharge
- Cocoa Bean Receiving Area Baghouse #2 (N0 11) - Internal Discharge
- Cocoa Bean Receiving, Cleaning & Conveying Baghouse# I - Internal Discharge
- Dark Chocolate Conveying Baghouse
- Lime Storage Silo - Waste Water Treatment Plant
- Buhler Building NG-Fired Emergency Generator (No Federal Requirements)
- Winnowing Fines Collector (Silo Area) - Internal Discharge
- Hull Bin Exhaust Fan

002: Each of the following miscellaneous sources account for less than 2.7 tpy of VOC emissions and are subject to the presumptive RACT2 requirements of 25 Pa Code Section 129.97, and are required to operate in accordance with the manufacturer's specifications and with good operating practices:

- Nib Grinders (Source 602)
- Alkalizer and NG-Fired Dryer - Internal Discharge
- NG-Fired Warehouse Space Heater
- R&D Pilot Plant Operations
- R&D Micronizer
- R&D Roaster
- R&D Fryer Hood
- Liquor Milling Areas (3)
- Liquor Storage



***** End of Report *****
